



AKANTE®

[www.akante.com](http://www.akante.com)



**TABLES BASSES**  
*COFFEE TABLES*  
COUCHTISCHE

**COINS CANAPÉ**  
*END TABLE*  
BEISTELLTISCHE

**CONSOLES**  
*CONSOLE TABLES*  
KONSOLE

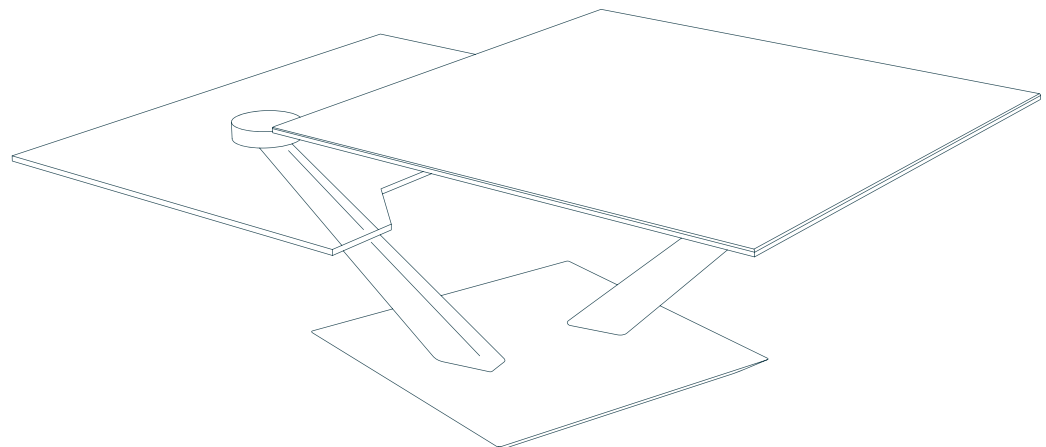

# AKANTE®

ALICANTE®



# ALICANTE<sup>®</sup>

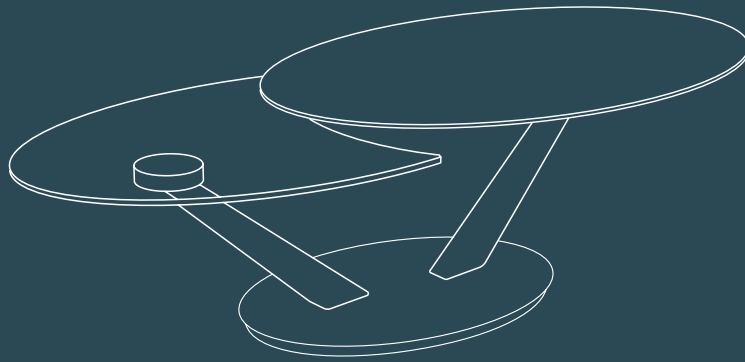

## TABLE BASSE CT274

Plateau supérieur à mécanisme synchronisé en céramique de 3 mm collée sur un verre de 6 mm  
Plateau inférieur en verre trempé de 10 mm  
Piétement : Acier laqué noir mat

Dimensions fermée : 95 x 80 x h40 cm  
Dimensions ouverte : 135 x 80 x h40 cm  
Poids Net : 49,5 kg

CT274SI / AR / MA / SD / TI / CC :

Plateau céramique silver / argile / marbre mat / acier / titane / chêne clair

© Modèle déposé (Réf. INPI : 20231433)

## COFFEE TABLE CT274

Main plate with synchronized system in ceramic over glass thickness 3 + 6 mm  
Tempered glass second plate 10 mm  
Legs : Black lacquered steel

Dimensions closed : 95 x 80 x h40 cm  
Dimensions open : 135 x 80 x h40 cm  
Net Weight : 49,5 kgs

CT274SI / AR / MA / SD / TI / CC :

Ceramic plate silver / clay / marble matt / steel / titanium / clear oak

© Registered design (INPI : 20231433)

## COUCHTISCH CT274

Obere Platte aus 3 mm Keramik verklebt auf 6 mm starkem Glas mit synchronisiertem Mechanismus  
Untere Platte aus 10 mm starkem Temperglas  
Gestell aus schwarz matt lackiertem Stahl

Abmessung geschlossen: 95 x 80 x H40 cm  
Abmessung geöffnet: 135 x 80 x H40 cm  
Nettogewicht: 49,5 kg

CT274SI / AR / MA / SD / TI / CC:

Keramikplatte silver / zementgrau / Marmoroptik matt / rostbraun / Titan / eiche hell

© Registriertes Modell (INPI : 20231433)

# AKANTE®

ALICIA - ELLIPSE®



ET060AR



ET060MA



ET061C



ET061SD



CT102R



CT102SI2



CT102SD



CT102MO\_C



CT102MC\_C



# ALICIA<sup>®</sup>

## COIN CANAPÉ ET060 / 61

ET060 : Piétement acier inoxydable poli  
ET061 : Piétement acier inoxydable brossé

Plateau en verre 8 mm ou céramique sur  
verre 3+6 mm  
Vaste choix de finitions

Dimensions : 50 x 50 x h66 cm  
Poids Net : 8 kg

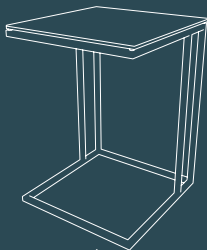

## COIN CANAPÉ ET062TI

Plateau céramique titane sur verre 3+6 mm  
Piétement acier laqué noir

Dimensions : 42 x 35 x h66 cm  
Poids Net : 7 kg

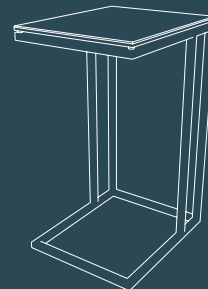

## END TABLE ET060 / 61

ET060 : Frame in polished stainless steel  
ET061 : Frame in brushed stainless steel

Top in glass 8 mm or ceramic over glass 3+6 mm  
Large choice of finishes

Dimensions : 50 x 50 x H66 cm  
Net weight : 8 kgs

## END TABLE ET062TI

Titanium ceramic plate on glass 3+6 mm  
Black lacquered steel base

Dimensions : 42 x 35 x H66 cm  
Net weight : 7 kgs

## BEISTELLTISCH ET060 / 61

ET060: Gestell aus poliertem Edelstahl  
ET061: Gestell aus gebürstetem Edelstahl

Glasplatte 8 mm oder Keramik auf Glas 3+6 mm  
Große Auswahl an Ausführungen

Abmessung: 50 x 50 x H66 cm  
Nettogewicht: 8 kg

## BEISTELLTISCH ET062TI

Keramikplatte titan auf Glas 3+6 mm  
Gestell aus schwarz lackiertem Edelstahl

Abmessung: 42 x 35 x H66 cm  
Nettogewicht: 7 kg

# ELLIPSE<sup>®</sup>

## TABLE BASSE CT102

Base en acier inoxydable poli  
Vaste choix de finitions pour les plateaux  
supérieurs et inférieurs

Dimensions : Ø 90 x h40 cm  
Poids Net : 32 kg

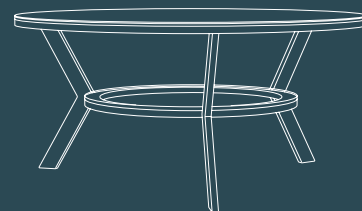

© Modèle déposé (Réf. INPI : 20173908)

## COFFEE TABLE CT102

Polished stainless steel base  
Large choice of finishes for tops and shelves

Dimensions : Ø 90 x H40 cm  
Net Weight : 32 kgs

© Registered design (INPI : 20173908)

## COUCHTISCH CT102

Gestell aus poliertem Edelstahl  
Große Auswahl an Ausführungen  
für die oberen und unteren Tischplatte

Abmessung: Ø 90 x H40 cm  
Nettogewicht: 32 kg

© Registriertes Modell (INPI 20173908)

# AKANTE®

ALTA

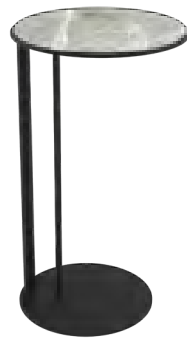

# ALTA

## COIN CANAPÉ

Pieds en acier laqué noir mat

### ET410CG2 :

Dessus céramique anthracite  
Dimensions : Ø 25 x h50 cm  
Poids Net : 3,6 kg

### ET412CM :

Dessus céramique marbre  
Dimensions : Ø 30 x h54 cm  
Poids Net : 4,8 kg

### ET410CW :

Dessus céramique blanche  
Dimensions : Ø 25 x h50 cm  
Poids Net : 3,6 kg

### ET412JA :

Dessus céramique jade  
Dimensions : Ø 30 x h54 cm  
Poids Net : 4,8 kg

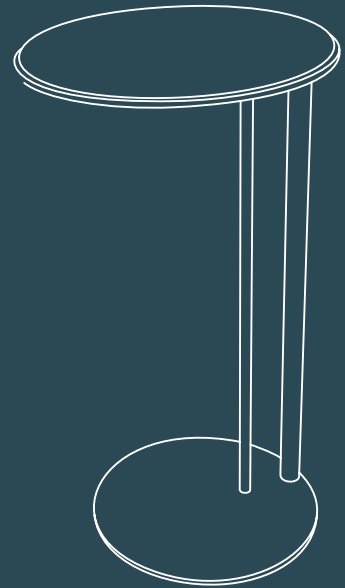

## END TABLE

Black lacquered steel legs

### ET410CG2 :

Top in charcoal ceramic  
Dimensions : Ø 25 x H50 cm  
Net Weight : 3,6 kgs

### ET412CM :

Top in marble ceramic  
Dimensions : Ø 30 x H54 cm  
Net Weight : 4,8 kgs

### ET410CW :

Top in white ceramic,  
Dimensions : Ø 25 x H50 cm  
Net Weight : 3,6 kgs

### ET412JA :

Top in jade ceramic  
Dimensions : Ø 30 x H54 cm  
Net Weight : 4,8 kgs

## BEISTELLTISCH

Füße aus Edelstahl Schwarz Lackiert

### ET410CG2:

Tischplatte aus Keramik in Anthrazit  
Abmessung: Ø 25 x H50 cm  
Nettogewicht: 3,6 kg

### ET412CM:

Tischplatte aus Keramik in Marmoroptik  
Abmessung: Ø 30 x H54 cm  
Nettogewicht: 4,8 kg

### ET410CW:

Tischplatte aus Keramik in weiß  
Abmessung: Ø 25 x H50 cm  
Nettogewicht: 3,6 kg

### ET412JA:

Tischplatte aus Keramik in Jade  
Abmessung: Ø 30 x H54 cm  
Nettogewicht: 4,8 kg



# AKANTE®

ARIZONA®



# ARIZONA<sup>®</sup>

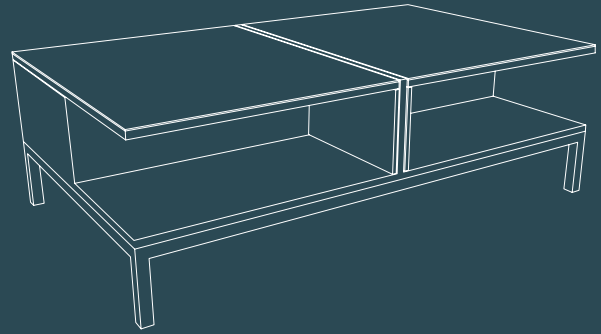

## TABLE BASSE CT255SD

2 plateaux amovibles en céramique acier sur MDF  
Structure en MDF laqué taupe  
Piètement en acier inoxydable poli (équipé de patins réglables)

Dimensions : 120 x 70 x h40 cm  
Hauteur déployée : 60 cm  
Poids Net : 63 kg

© Modèle déposé (Réf. INPI : 20173908)

## COFFEE TABLE CT255SD

2 adjustable trays in steel ceramic over MDF  
Structure in taupe lacquered MDF  
Polished stainless steel legs (with built-in levellers)

Dimensions : 120 x 70 x H40 cm  
Height lifted up: 60 cm  
Net weight : 63 kgs

© Registered design (INPI : 20173908)

## COUCHTISCH CT255SD

2 hochklappbare Tischplatten aus Keramik auf MDF  
Korpus aus MDF taupe lackiert  
Gestell aus poliertem Stahl (mit plastikkappe)

Abmessung: 120 x 70 x H40 cm  
Höhe bei hochgeklappter Platte: 60 cm  
Nettogewicht: 63 kg

© Registriertes Modell (INPI : 20173908)

# AKANTE

ARTÉMIS ©



# ARTÉMIS<sup>®</sup>

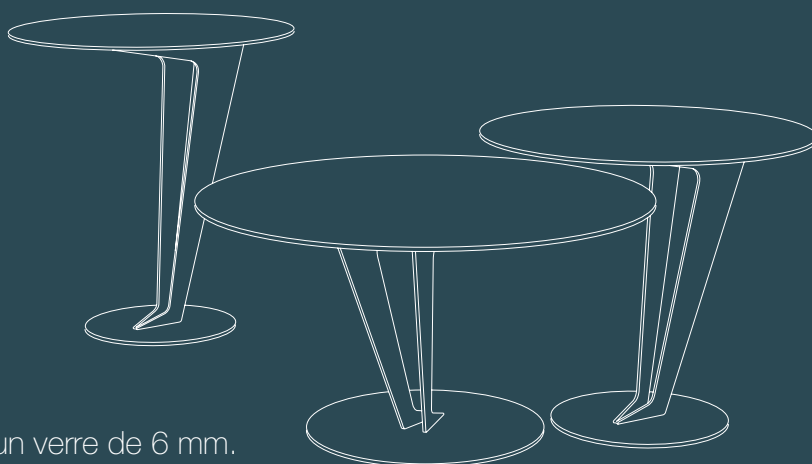

 Plateau en céramique de 3 mm collé sur un verre de 6 mm.  
Piétement : Acier laqué noir mat

Céramiques AR / SD / MA / TI / SI : Argile / Acier / Marbre mat / Titane / Silver

## TABLE BASSE

CT143

CT143 : Dimensions : Ø 75 x h40 cm  
Poids Net : 29 kg

## BOUT DE CANAPÉ

ET142 / ET143

ET142 : Dimensions : Ø 55 x h50 cm  
Poids Net : 18,5 kg

ET143 : Dimensions : Ø 55 x h60 cm  
Poids Net : 19 kg

© Modèle déposé (Réf. INPI : 20215513)

 Top 3 mm Argile ceramic over 6 mm glass.  
Legs : Matt black lacquered steel

Ceramics AR / SD / MA / TI / SI : Argile / Steel Dark / Matt Marble / Titanium / Silver

## COFFEE TABLE

CT143

CT143 : Dimensions : Ø 75 x H40 cm  
Net Weight : 29 kg

## SIDE TABLE

ET142 / ET143

ET142 : Dimensions : Ø 55 x H50 cm  
Net Weight : 18,5 kg

ET143 : Dimensions : Ø 55 x H60 cm  
Net Weight : 19 kgs

© Registered design (INPI : 20215513)

 Untereplatte 3 mm Keramikplatte verklebt auf 6 mm starkem Glas  
Rahmen: Stahl mattschwarz lackiert

Keramik AR / SD / MA / TI / SI: Zementgrau / Rostbraun / Marmoroptik matt / Titan / Silber

## COUCHTISCH

CT143

CT143: Abmessung: Ø 75 x h40 cm  
Nettogewicht: 29 kg

## BEISTELLTISCH

ET142 / ET143

ET142: Abmessung: Ø 55 x h50 cm  
Nettogewicht: 18,5 kg

ET143: Abmessung: Ø 55 x h60 cm  
Nettogewicht: 19 kg

© Registriertes Modell (INPI : 20215513)

# AKANTE®

ASTORIA



CT012



CT014R



# ASTORIA

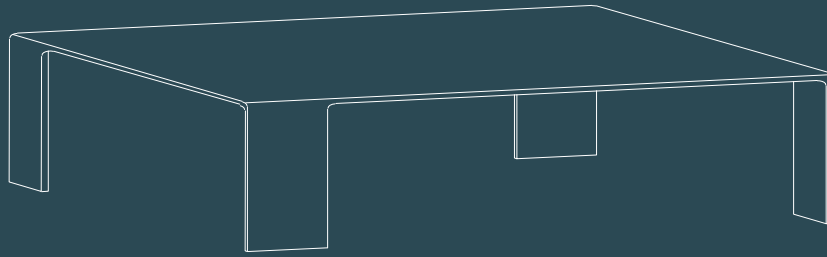

## TABLE BASSE

CT010C

Verre clair courbé à chaud haute résistance.  
Épaisseur : 12 mm  
Dimensions : 120 x 120 x 35 cm  
Poids Net : 50 kg

## TABLE BASSE

CT014R

Verre Cristallin courbé à chaud haute résistance.  
Épaisseur : 12 mm  
Dimensions : 110 x 70 x 35 cm  
Poids Net : 35 kg

## TABLE BASSE

CT012

Verre clair courbé à chaud haute résistance.  
Épaisseur : 12 mm  
Dimensions : 110 x 110 x 38 cm  
Poids Net : 45 kg

CT012 : Verre Clair / CT012R : Verre Cristallin

## COFFEE TABLE

CT010C

High resistance hot bent glass  
Thickness : 12 mm  
Dimensions : 120 x 120 x 35 cm  
Net Weight : 50 kgs

## COFFEE TABLE

CT014R

High resistance Crystal hot bent glass  
Thickness : 12 mm  
Dimensions : 110 x 70 x 35 cm  
Net Weight : 35 kgs

## COFFEE TABLE

CT012

High resistance hot bent glass  
Thickness : 12 mm  
Dimensions : 110 x 110 x 38 cm  
Net Weight : 45 kgs

CT012 : Clear glass / CT012R : Crystal glass

## COUCHTISCH

CT010C

Glas hitzegebogen, hochresistent  
Glasstärke: 12 mm  
Abmessung: 120 x 120 x 35 cm  
Nettogewicht: 50 kg

## COUCHTISCH

CT014R

Glas hitzegebogen, ultraklar hochresistent.  
Glasstärke: 12 mm  
Abmessung: 110 x 70 x 35 cm  
Nettogewicht: 35 kg

## COUCHTISCH

CT012

Glas hitzegebogen, hochresistent  
Glasstärke: 12 mm  
Abmessung: 110 x 110 x 38 cm  
Nettogewicht: 45 kg

CT012 : Klarglas / CT012R : ultraklares Glas

# AKANTE®

ATENA

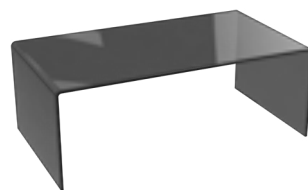
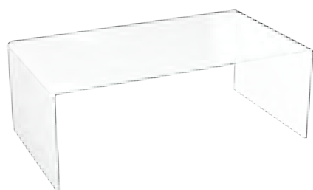
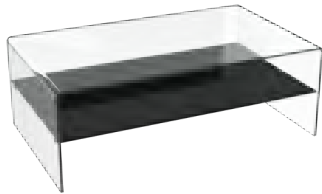
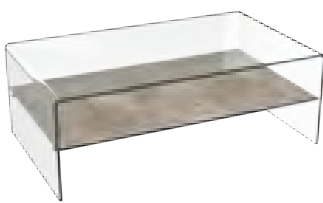

# ATENA

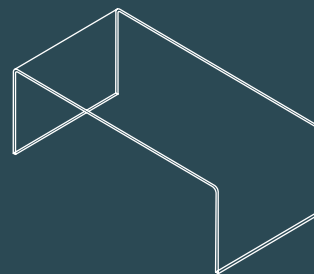
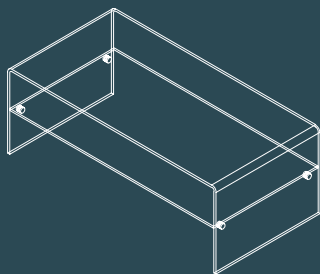

 Verre courbé à chaud haute résistance  
Epaisseur 10 mm. Etagère en verre trempé de 10 mm.

## TABLE BASSE

### CT072

Table et étagère en verre clair

Dimensions : 120 x 60 x 42 cm

Poids Net : 52,5 kg

### CT070

Table en verre Cristallin

Etagère : vaste choix de finitions

Dimensions : 113 x 66 x 40 cm

Poids Net : 49 kg

 Verre courbé à chaud haute résistance  
Epaisseur 12 mm.

## TABLE BASSE

### CT071R / CT071G

Table en Cristallin / Gris fumé

Dimensions : 110 x 60 x 40 cm

Poids Net : 34 kg

 High resistance hot bent glass  
Thickness 10 mm. Shelf 10 mm tempered glass.

## COFFEE TABLE

### CT072

Table and shelf in clear glass

Dimensions : 120 x 60 x 42 cm

Net Weight : 52,5 kgs

### CT070

Table in Crystal\* glass

Shelf : large choice of finishes

Dimensions : 113 x 66 x 40 cm

Net Weight : 49 kgs

 High resistance hot bent glass  
thickness 12 mm.

## COFFEE TABLE

### CT071R / CT071G

Table in Crystal\* glass / Tinted Grey

Dimensions : 110 x 60 x 40 cm

Net Weight : 34 kgs

 Hochbeständiges hitzegebogenes Glas Dicke: 10 mm.  
Ablagefach aus 10 mm Temperglas.

## COUCHTISCH

### CT072

Tisch- & Zwischenplatte  
aus Klarglas

Abmessung: 120 x 60 x 42 cm

Nettogewicht: 52,5 kg

### CT070

Tischplatte aus ultraklarem Glas  
Zwischenplatte: große Auswahl  
an Ausführungen

Abmessung: 113 x 66 x 40 cm

Nettogewicht: 49 kg

 Hochbeständiges hitzegebogenes Glas  
Dicke: 12 mm.

## COUCHTISCH

### CT071R / CT071G

Tischplatte aus ultraklarem Glas / Grau  
Getönt

Abmessung: 110 x 60 x 40 cm

Nettogewicht: 34 kg

\* Low iron glass



# AKANTE®

AURORA

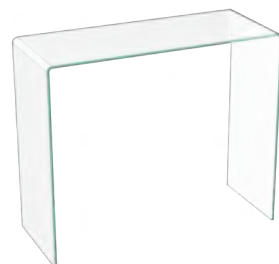

# AURORA

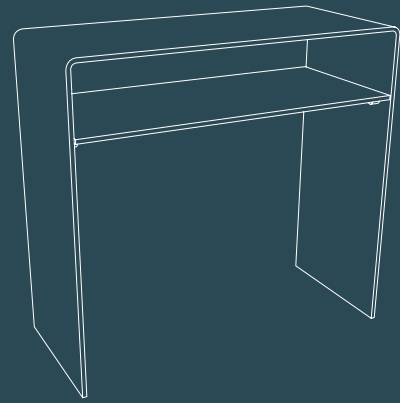
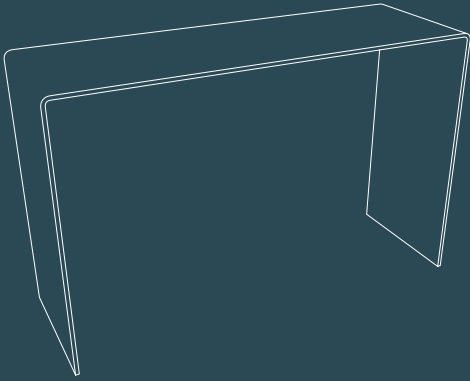

## CONSOLE

Verre courbé à chaud haute résistance, épaisseur de 12 mm.

**ST004R** : Verre cristallin

Dimensions : 70 x 30 x h75 cm

Poids Net : 18 kg

**ST006/ST006R**

Dimensions : 120 x 40 x h75 cm

Poids Net : 32 kg

**ST006** : Verre clair

**ST006R** : Verre cristallin

**ST009/ST011**

Dimensions : 90 x 36 x h75 cm

Poids Net : 25 kg

**ST009** : Verre clair

**ST011R** : Verre cristallin

**ST011G** : Verre gris fumé

## CONSOLE AVEC TABLETTE

Verre Cristallin courbé à chaud haute résistance, épaisseur de 10 mm.

**ST003**

Etagère disponible dans un large choix de finitions.

Dimensions : 103 x 39 x h75 cm

Poids Net : 34 kg

**ELIA : ST019C**

Étagère en verre trempé de 10 mm

Dimensions : 80 x 30 x h75 cm

Poids Net : 32 kg

## CONSOLE TABLE

High resistance hot bent glass, thickness 12 mm.

**ST004R** : Crystal\* glass

Dimensions : 70 x 30 x H75 cm

Net Weight : 18 kgs

**ST006/ST006R**

Dimensions : 120 x 40 x H75 cm

Net Weight : 32 kgs

**ST006** : Clear glass

**ST006R** : Crystal\* glass

**ST009/ST011**

Dimensions : 90 x 36 x H75 cm

Net Weight : 25 kgs

**ST009** : Clear glass

**ST011R** : Crystal\* glass

**ST011G** : Grey tinted glass

## CONSOLE WITH TABLET

High resistance hot bent Crystal\* glass, thickness 10 mm.

**ST003**

Shelf available in a wide range of finishes.

Dimensions : 103 x 39 x H75 cm

Net Weight : 34 kgs

**ELIA : ST019C**

10 mm tempered glass shelf.

Dimensions : 80 x 30 x H75 cm

Net Weight : 32 kgs

## KONSOLE

Glas hitzegebogen hochbelastbar, Dicke 12 mm.

**ST004R**: Glas ultraklar

Abmessung: 70 x 30 x H75 cm

Nettogewicht: 18 kg

**ST006/ST006R**

Abmessung: 120 x 40 x H75 cm

Nettogewicht: 32 kg

**ST006**: Klarglas

**ST006R**: Glas ultraklar

**ST009/ST011**

Abmessung: 90 x 36 x H75 cm

Nettogewicht: 25 kg

**ST009**: Klarglas

**ST011R**: Glas ultraklar

**ST011G**: Grau getönt

## KONSOLE

Glas ultraklar hitzegebogen hochbelastbar, Dicke 10 mm.

**ST003**

Große Auswahl an Ausführungen.

Abmessung: 103 x 39 x H75 cm

Nettogewicht: 34 kg

**ELIA : ST019C**

Ablage aus 10mm starkem Temperglas.

Abmessung: 80 x 30 x H75 cm

Nettogewicht: 32 kg

# AKANTE®

BARCELONA®



# BARCELONA<sup>®</sup>

## TABLE BASSE CT133 / CT233 / CT333

Plateau inférieur en verre clair trempé 10 mm

CT133 : Base en acier laqué noir mat (équipée de patins réglables)

CT233 : Base en acier laqué taupe (équipée de patins réglables)

CT333 : Base en acier laqué noir mat équipée de roulettes

CH : Plateau supérieur en MDF plaqué chêne

C : Plateau supérieur en verre clair trempé 12 mm

Céramiques MA / SD / AR / SI / TI / CC :

Plateau supérieur en céramique marbre mat / acier / silver  
argile / titane / chêne clair ép. 3 mm sur verre 6 mm

Dimensions fermées : 95 x 60 x h42 cm

Dimensions ouvertes : 163 x 60 x h42 cm

Poids Net : 47 kg

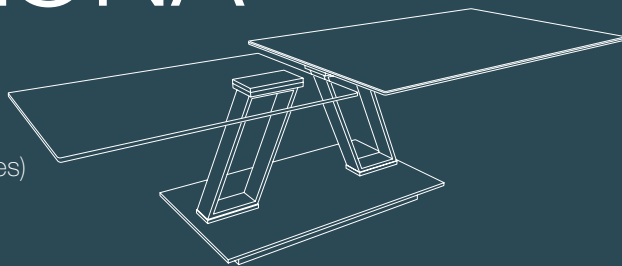

© Modèle déposé (Réf. INPI : 20173908)

## COFFEE TABLE CT133 / CT233 / CT333

Lower top in 10 mm clear glass

CT133 : Base black lacquered steel (with built-in levellers)

CT233 : Base taupe lacquered steel (with built-in levellers)

CT333 : Base black lacquered steel - with wheels

CH : Top plate in oak veneered MDF

C : Top plate in 12 mm clear tempered glass

Ceramics MA / SD / AR / SI / TI / CC :

Top in 3 mm matt marble / steel / argile / silver /  
titanium clear oak ceramic over 6 mm glass

Dimensions closed : 95 x 60 x H42 cm

Dimensions opened : 163 x 60 x H42 cm

Net Weight : 47 kgs

© Registered design (INPI : 20173908)

## COUCHTISCH CT133 / CT233 / CT333

Untere Platte aus Klarglas 10 mm

CT133: Gestell aus Stahl, schwarz lackiert (mit plastikkappe)

CT233: Gestell aus Stahl, taupe lackiert (mit plastikkappe)

CT333: Gestell aus Stahl, schwarz lackiert - auf Rollen

CH: Obereplatte aus MDF mit Eichenfurnier

C: Oberplatte aus getempertem Klarglas 12 mm

Keramiken MA / SD / AR / SI / TI / CC:

Oberplatte aus Keramik Marmoroptik / rostbraun / silber  
zementgrau / Titan / eiche hell auf Glas, Stärke 3 + 6 mm

Abmessung geschlossen: 95 x 60 x H42 cm

Abmessung geöffnet: 163 x 60 x H42 cm

Nettogewicht: 47 kg

© Registriertes Modell (INPI 20173908)

# AKANTE®

BERGAMO ©



# BERGAMO<sup>®</sup>

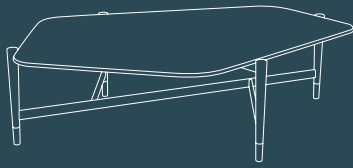

CT016

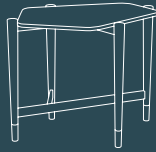

ET016

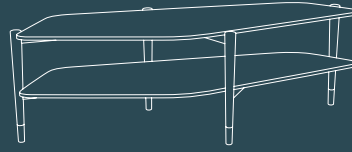

TV016

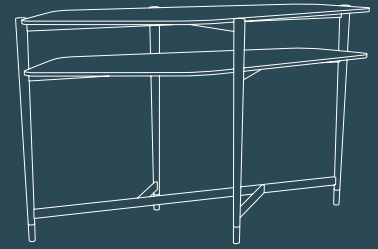

ST026

 Plateaux : Céramique pleine masse de 11 mm d'épaisseur, couleurs : marbre Marquina (**MM**), marbre Calcatta (**MC**), marbre Onyx bleu (**MO**), marbre Emperador (**ME**)

Pieds en acier laqué noir mat, finition laiton

**TABLE BASSE** CT016  
Dimensions : 121 x 84 x h38 cm  
Poids Net : 24,15 kg

**CONSOLE** ST026  
Dimensions : 120 x 41 x h75 cm  
Poids Net : 24 kg

**COIN CANAPÉ** ET016 / ET018 / ET019  
Dimensions : 59 x 40,5 x h38 / 43 / 50 cm  
Poids Net : 7 kg

**MEUBLE TV** TV016  
Dimensions : 120 x 41 x h36 cm  
Poids Net : 22 kg

© Modèles déposés (Réf. INPI : 20231433)

 Plates : Full body ceramic thickness 11 mm, colours : Marquina marble (**MM**), Calcatta marble (**MC**), Onyx blue marble (**MO**), Emperador marble (**ME**)

Legs in matt black lacquered steel, brass finish

**COFFEE TABLE** CT016  
Dimensions : 121 x 84 x h38 cm  
Net Weight : 24,15 kgs

**CONSOLE** ST026  
Dimensions : 120 x 41 x h75 cm  
Net Weight : 24 kgs

**END TABLE** ET016 / ET018 / ET019  
Dimensions : 59 x 40,5 x h38 / 43 / 50 cm  
Net Weight : 7 kgs

**TV SET** TV016  
Dimensions : 120 x 41 x h36 cm  
Net Weight : 22 kgs

© Registered design (INPI : 20231433)

 11 mm dicke Vollkeramik, farben: Marmoroptik Marquina (**MM**), Marmoroptik Calcatta (**MC**), Marmoroptik Onyx blau (**MO**), Marmoroptik Emperador (**ME**)

Gestell: Schwartz lackieren Stahl mit Messing-Finish

**COUCHTISCH** CT016  
Abmessung: 121 x 84 x H38 cm  
Nettogewicht: 24,15 kg

**KONSOLE** ST026  
Abmessung: 120 x 41 x H75 cm  
Nettogewicht: 24 kg

**BEISTELLTISCH** ET016 / ET018 / ET019  
Abmessung: 59 x 40,5 x H38 / 43 / 50 cm  
Nettogewicht: 7 kg

**TV MEDIAMÖBEL** TV016  
Abmessung: 120 x 41 x H36 cm  
Nettogewicht: 22 kg

© Registriertes Modell (INPI: 20231433)

# AKANTE®

BLACK SQUAD - SQUARE®

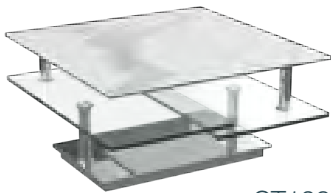

CT128MA



CT128SD

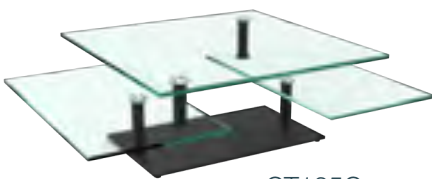

CT135C

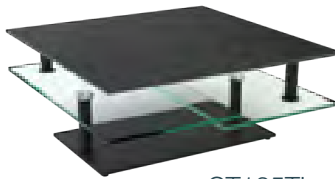

CT135TI



CT135AR



# BLACK SQUAD - SQUARE<sup>®</sup>

## TABLE BASSE

CT135 / CT128

Plateau supérieur : Céramique de 3 mm collée sur un verre de 6 mm

Plateaux inférieurs : Verre clair trempé 10 mm

CT135 : Base et pieds : Acier laqué noir (équipé de patins réglables)

CT128 : Base et pieds : Acier chromé (équipé de patins réglables)

Dimension fermée : 80 x 80 x h40 cm

Dimension ouverte : 118 x 80 x h40 cm

Poids Net : 68 kg

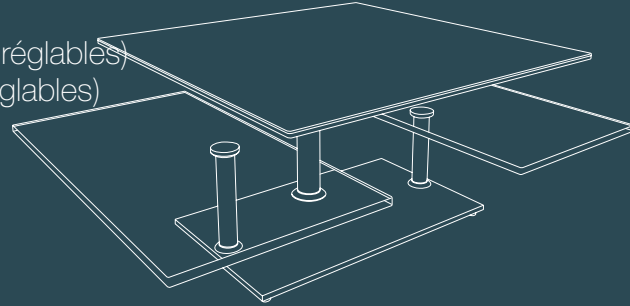

CT135 / CT128C : Plateau supérieur en verre clair trempé 10 mm

Céramiques AR / MA / SD / TI / SI :

Plateau supérieur en céramique argile / marbre mat / acier / titane / silver

## COFFEE TABLE

CT135 / CT128

Upper Top : Ceramic over glass thickness 3 + 6 mm

Lower Tops : 10 mm clear tempered glass

CT135 : Base and legs : Black lacquered steel (with built-in levellers)

CT128 : Base and legs : Chrome steel (with built-in levellers)

Dimension closed : 80 x 80 x H40 cm

Dimension open : 118 x 80 x H40 cm

Net Weight : 68 kgs

CT135 / CT128C : Upper top in 10 mm clear tempered glass

Ceramics AR / MA / SD / TI / SI :

Upper top in ceramic argile / matt marble / steel / titanium / silver

## COUCHTISCH

CT135 / CT128

Oberplatte: Keramik auf Glas Stärke 3 + 6 mm

Untere Platten: 10 mm starkes Temperglas

CT135: Gestell aus Stahl: schwarz lackiert (mit plastikkappe)

CT128: Gestell aus Stahl: Stahl verchromt (mit plastikkappe)

Abmessung geschlossen: 80 x 80 x H40 cm

Abmessung geöffnet: 118 x 80 x H40 cm

Nettogewicht: 68 kg

CT135 / CT128C: Oberplatte 10 mm starkes Temperglas klar

Keramiken AR / MA / SD / TI / SI:

Oberplatte in Keramik zementgrau / Marmoroptik matt / rostbraun / Titan / silver



# AKANTE®

BOSTON®



# BOSTON<sup>®</sup>

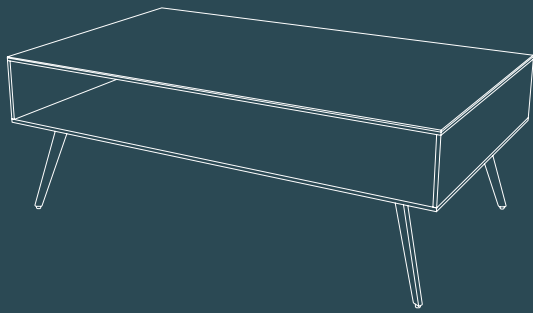

 Plateau supérieur en céramique acier de 3 mm collée sur un verre de 8 mm.  
Caisson en verre gris fumé de 10 mm. Piètement en acier laqué noir mat (équipé de patins réglables).

**TABLE BASSE**      **CT050SD**  
Dimensions : 110 x 65 x h40 cm

Poids Net : 45 kg

**CONSOLE**      **ST050SD**  
Dimensions : 90 x 30 x h75 cm

Poids Net : 25 kg

**BUREAU**      **BU050SD**  
Dimensions : 120 x 60 x h75 cm

Poids Net : 47 kg

© Modèle déposé (Réf. INPI : 20173908)

 Top in 3 mm steel dark ceramic glued on a 8 mm thick glass.  
10 mm smoked grey glass body. Legs in matt black lacquered steel (with built-in levellers).

**COFFEE TABLE**      **CT050SD**  
Dimensions : 110 x 65 x H40 cm

Net Weight : 45 kgs

**CONSOLE**      **ST050SD**  
Dimensions : 90 x 30 x H75 cm

Net Weight : 25 kgs

**DESK**      **BU050SD**  
Dimensions : 120 x 60 x H75 cm

Net Weight : 47 kgs

© Registered design (INPI : 20173908)

 Oberplatte aus 3 mm Keramik in Rostbraun auf 8 mm Glas.  
Korpus aus 10 mm grau getöntem Glas - Füße aus schwarz lackiertem Stahl (mit plastikkappe).

**COUCHTISCH**      **CT050SD**  
Abmessung: 110 x 65 x H40 cm

Nettogewicht: 45 kg

**KONSOLE**      **ST050SD**  
Abmessung: 90 x 30 x H75 cm

Nettogewicht: 25 kg

**SCHREIBTISCH**      **BU050SD**  
Abmessung: 120 x 60 x H75 cm

Nettogewicht: 47 kg

© Registriertes Modell (INPI 20173908)

# AKANTE®

BOUSSOLE - CADRAN®



# BOUSSOLE - CADRAN<sup>®</sup>

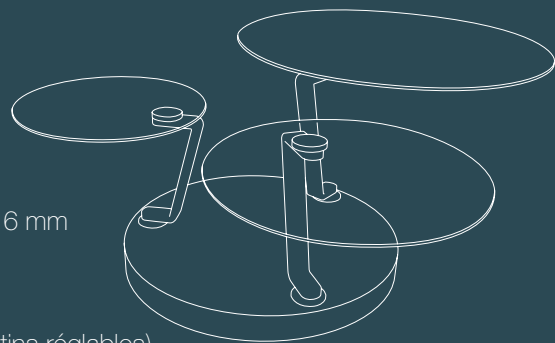

## TABLE BASSE CT297 / CT296

3 plateaux synchronisés de diamètre 77, 46 et 40 cm

CT297 / 296 : Plateau supérieur : Céramique collée sur verre épaisseur 3 + 6 mm  
Plateaux inférieurs : Verre clair trempé 10 mm

CT297 : Base et pieds en acier laqué noir mat (équipé de patins réglables)

CT296 : Base en acier laqué noir mat et pieds en acier chromé (équipé de patins réglables)

Dimensions fermée : 77 cm      Dimensions ouverte : 132 cm      Hauteur : 43 cm      Poids Net : 59 kg

CT297 / 296C : 3 plateaux en verre clair trempé 10 mm

CT297 / 296CH : Plateau supérieur en MDF plaqué chêne

Céramiques AR / SD / TI / MA / SI / CC : Plateau supérieur en céramique argile / acier / titane / marbre / silver / chêne clair

© Modèle déposé (ref INPI : 20173908)

## COFFEE TABLE CT297 / CT296

3 synchronised tops of diameter 77, 46 and 40 cm

CT297 / 296 : Top plate : Ceramic over glass thickness 3 + 6 mm  
Lower plates : 10 mm clear tempered glass

CT297 : Base in black painted steel and legs in chrome steel (with built-in levellers)

CT296 : Base and legs in matt black painted steel (with built-in levellers)

Dimensions closed : 77 cm      Dimensions opened : 132 cm      Height : 43 cm      Net weight : 59 kgs

CT297 / 296C : 3 plates in clear tempered glass 10 mm

CT297 / 296CH : Main plate in MDF oak veneer

Ceramics AR / SD / TI / MA / SI / CC : Top Plate in ceramic argile / steel dark / titanium / matt marble / silver / clear oak

© Registered design (INPI : 20173908)

## COUCHTISCH CT297 / CT296

3 synchronisierte Platten mit Durchmesser 77, 46 und 40 cm

CT297 / 296: Obere Platte: Keramik auf Glas Stärke 3 + 6mm  
Untere Platten: Aus klarem Temperglas Stärke 10 mm

CT297: Bodenplatte aus Stahlschwarz matt lackiert-Gestell aus Stahl verchromt (mit plastikkappe)

CT296: Bodenplatte und Gestell aus mattschwarz lackiertem Stahl (mit plastikkappe)

Abmessung geschlossen: 77 cm      Abmessung geöffnet: 132 cm      Höhe: 43 cm      Nettogewicht: 59 kg

CT297 / 296C: 3 Platten aus klarem Temperglas Stärke 10 mm

CT297 / 296CH: Obere Platte aus MDF mit Eichenfurnier

Keramiken AR / SD / TI / MA / SI / CC: Obere Platte aus Keramik zementgrau / rostbraun / Titan / Marmoroptik matt / silver / eiche hell

© Registriertes Modell (INPI : 20173908)

# AKANTE®

BRASILIA®



# BRASILIA<sup>®</sup>

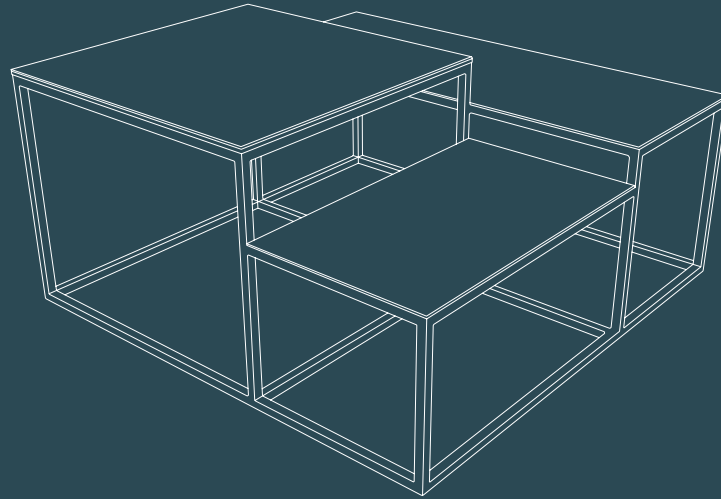

## TABLE BASSE

CT300

Plateau supérieur en céramique de 3 mm collé sur un verre de 6 mm ou en verre trempé de 10 mm  
Vaste choix de finitions pour ce plateau supérieur  
Structure en acier laqué noir mat  
Dimensions : 80 x 80 x 40 cm  
Poids Net : 42 kg

CT300 : Plateau intermédiaire et inférieur en céramique acier collés sur la structure  
CT301 : Plateau intermédiaire et inférieur en céramique argile collés sur la structure  
CT302 : Plateau intermédiaire et inférieur en céramique titane collés sur la structure

© Modèle déposé (Réf. INPI : 20173908)

## COFFEE TABLE

CT300

Top in ceramic over glass 3 + 6 mm or in tempered clear glass thickness 10 mm  
Large choice of finishes for upper plates  
Structure in mat black painting steel  
Dimensions : 80 x 80 x 40 cm  
Net Weight : 42 kgs

CT300 : Middle and lower plates in steel dark ceramic glued on the structure  
CT301 : Middle and lower plates in argile ceramic glued on the structure  
CT302 : Middle and lower plates in titanium ceramic glued on the structure

© Registered design (INPI : 20173908)

## COUCHTISCH

CT300

Oberplatte: Keramik auf Glas 3 + 6 mm oder Temperglas 10 mm  
Große Auswahl an Ausführungen für die obere Platte  
Gestell aus Stahl schwarz matt lackiert  
Abmessung: 80 x 80 x 40 cm  
Nettogewicht: 42 kg

CT300: Untere und mittlere Platte in Keramik rostbraun auf Gestell verklebt  
CT301: Untere und mittlere Platte in Keramik zementgrau auf Gestell verklebt  
CT302: Untere und mittlere Platte in Keramik Titan auf Gestell verklebt

© Registriertes Modell (INPI 20173908)

# AKANTE®

BROOKLYN®



# BROOKLYN<sup>®</sup>



🇫🇷 Plateau supérieur pivotant en céramique rouille 5 mm collée sur MDF plaqué chêne  
Caisson en MDF plaqué chêne  
Pieds : Acier peinture epoxy noir mat

## TABLE BASSE CT425

Dimension fermée : Ø 85 x h40 cm  
Dimension ouverte : 115 x 85 x h40 cm  
Poids Net : 39 kg

## BOUT DE CANAPÉ ET425

Dimension fermée : Ø 44 x h54 cm  
Dimension ouverte : 64 x 44 x h54 cm  
Poids Net : 10 kg

© Modèle déposé Réf. INPI : 20205317)

🇬🇧 Upper pivoting 5 mm ceramic rust-coloured plate glued upon oak veneer MDF  
Body in oak veneer MDF  
Legs : Black epoxy painted steel

## COFFEE TABLE CT425

Dimension closed : Ø 85 x H40 cm  
Dimension open : 115 x 85 x H40 cm  
Net Weight : 39 kgs

## END TABLE ET425

Dimension closed : Ø 44 x H54 cm  
Dimension open : 64 x 44 x H54 cm  
Net Weight : 10 kgs

© Registered design (INPI : 20205317)

🇩🇪 Drehbare Oberplatte aus 5mm dicker Keramik rostbraun verklebt auf MDF mit Eiche  
Korpus aus MDF mit Eiche  
Gestell: Edelstahl pulverbeschichtet schwarz matt

## COUCHTISCH CT425

Abmessung geschlossen: Ø 85 x H40 cm  
Abmessung geöffnet: 115 x 85 x H40 cm  
Nettogewicht: 39 kg

## BEISTELLTISCH ET425

Abmessung geschlossen: Ø 44 x H54 cm  
Abmessung geöffnet: 64 x 44 x H54 cm  
Nettogewicht: 10 kg

© Registriertes Modell (INPI : 20205317)



# AKANTE®

CAPRI®



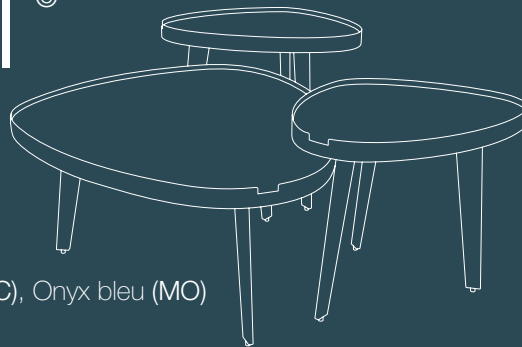

Plateau supérieur :

Céramique pleine masse de 11 mm, couleurs : Marquina (MM), Calcatta (MC), Onyx bleu (MO)  
Ceinture acier effet bronze ou acier laqué noir de 4 cm de hauteur

Piètement : Acier laqué noir mat (équipé de patins réglables)

## TABLE BASSE

Pieds pleins : CT314 / CT316 / CT317 / CT323  
CT324 / CT327 / CT328 / CT329

Pieds ajourés : CT514 / CT515 / CT516 / CT524  
CT535 / CT536 / CT537 / CT538

Dimensions : 92 x 76 x h33 cm  
h38 cm  
h43 cm  
h50 cm

Poids Net : 18 kg

## COIN CANAPÉ

Pieds pleins : ET314 / ET316 / ET317 / ET323  
ET324 / ET327 / ET328 / ET329

Pieds ajourés : ET514 / ET515 / ET516 / ET524  
ET535 / ET536 / ET537 / ET538

Dimensions : 55 x 45 x h33 cm  
h38 cm  
h43 cm  
h50 cm

Poids Net : 8,5 kg

© Modèle déposé (Réf. INPI : 20222320)



Top plate :

Full body ceramic thickness 11 mm, colours : Marquina (MM), Calcatta (MC), Onyx blue (MO)  
Steel frame with bronze effect or black lacquered steel, Height 4 cm

Legs : Black lacquered steel (with built-in levellers)

## COFFEE TABLE

Solid legs : CT314 / CT316 / CT317 / CT323  
CT324 / CT327 / CT328 / CT329

Open-style legs : CT514 / CT515 / CT516 / CT524  
CT535 / CT536 / CT537 / CT538

Dimensions : 92 x 76 x H33 cm  
H38 cm  
H43 cm  
H50 cm

Net weight : 18 kgs

## END TABLE

Solid legs : ET314 / ET316 / ET317 / ET323  
ET324 / ET327 / ET328 / ET329

Open-style legs : ET514 / ET515 / ET516 / ET524  
ET535 / ET536 / ET537 / ET538

Dimensions : 55 x 45 x H33 cm  
H38 cm  
H43 cm  
H50 cm

Net weight : 8,5 kgs

© Registered design (INPI : 20222320)



Tischplatte:

11 mm dicke Vollkeramik, farben: Marquina (MM), Calcatta (MC), Onyx blau (MO)  
Messingfarbener Stahlgürtel oder schwarz lackierter Stahl mit 4 cm Höhe

Gestell: Stahl schwarz matt lackiert (mit plastikkappe)

## COUCHTISCH

Tischbeine ganz: CT314 / CT316 / CT317 / CT323  
CT324 / CT327 / CT328 / CT329

Oder durchbrochen: CT514 / CT515 / CT516 / CT524  
CT535 / CT536 / CT537 / CT538

Abmessung: 92 x 76 x H33 cm  
H38 cm  
H43 cm  
H50 cm

Nettogewicht: 18 kg

## BEISTELLTISCH

Tischbeine ganz: ET314 / ET316 / ET317 / ET323  
ET324 / ET327 / ET328 / ET329

Oder durchbrochen: ET514 / ET515 / ET516 / ET524  
ET535 / ET536 / ET537 / ET538

Abmessung: 55 x 45 x H33 cm  
H38 cm  
H43 cm  
H50 cm

Nettogewicht: 8,5 kg

© Registriertes Modell (INPI : 20222320)

# AKANTE®

CELENO - ELYRA®



ET069MA



ET069AR



ET069SD



ET068SI



ET068TI



ET068CC



# CELENO - ELYRA<sup>®</sup>

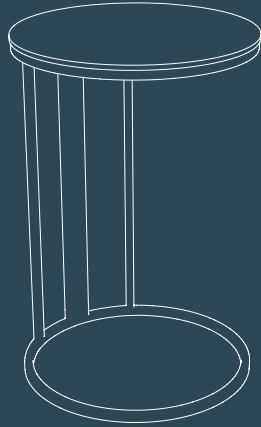

ET069

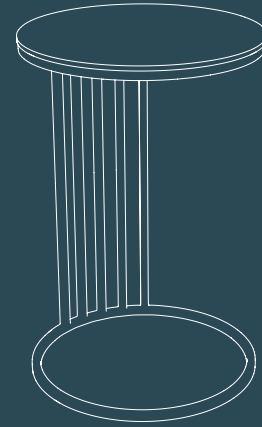

ET068

## COIN CANAPÉ ET069 / ET068

Plateau : Céramique de 3 mm collée sur un verre de 6 mm d'épaisseur, couleurs : Acier (SD), Argile (AR), Chêne clair (CC), Marbre mat (MA), Silver (SI), Titane (TI)  
Piétement : Acier laqué noir mat

Dimensions : 40 x h60 cm  
Poids Net : 11 kg

© Modèle déposé (Réf. INPI : 20215513)

## END TABLE ET069 / ET068

Top plate : Ceramic over glass thickness 3 + 6 mm, colours : Steel dark (SD), Argile (AR), Clear oak (CC), Matt marble (MA), Silver (SI), Titanium (TI)  
Legs : matt black lacquered steel

Dimensions : 40 x H60 cm  
Net weight : 11 kgs

© Registered design (INPI : 20215513)

## BEISTELLTISCH ET069 / ET068

Tischplatte: Keramik auf Glas 3+6 mm, farben: rostbraun (SD), zementgrau (AR), eiche hell (CC), Marmoroptik matt (MA), silver (SI), Titan (TI)  
Gestell: Schwartz lackieren Stahl

Abmessung: 40 x H60 cm  
Nettogewicht: 11 kg

© Registriertes Modell (INPI : 20215513)

# AKANTE®

CELIA®



# CELIA®

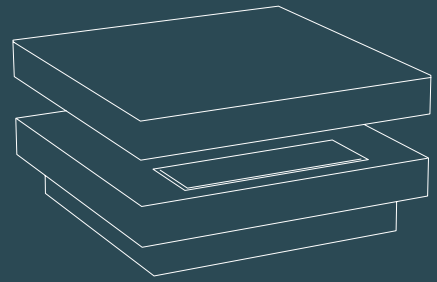
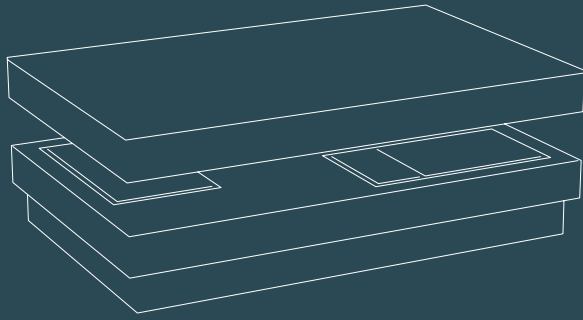

## TABLE BASSE CT111 / CT130

Plateau supérieur : Verre trempé laqué blanc de 6 mm sur MDF laqué blanc

CT111LG : Base en MDF laqué gris et casiers amovibles laqués blanc (équipée de patins réglables)

CT111LT : Base en MDF laqué taupe et casiers amovibles laqués blanc (équipée de patins réglables)

Dimensions fermée : 110 x 70 x h39 cm      Dimensions ouverte (1) : 140 x 70 x h39 cm

Poids Net : 59 kg      Dimensions ouverte (2) : 140 x 100 x h39 cm

© Modèle déposé (Réf. INPI : 20161761)

## COFFEE TABLE CT111 / CT130

Tops : White laquered tempered glass 6 mm over white glossy MDF

CT111LG : Base grey glossy MDF and removable rack in white glossy (with built-in levellers)

CT111LT : Base taupe glossy MDF and removable rack in white glossy (with built-in levellers)

Dimensions closed : 110 x 70 x H39 cm      Dimensions opened (1) : 140 x 70 x H39 cm

Net weight : 59 kgs      Dimensions opened (2) : 140 x 100 x H39 cm

© Registered design (Réf. INPI : 20161761)

## COUCHTISCH CT111 / CT130

Obere Platte: 6 mm dickes, weiß lackiertes Temperglas auf MDF

CT111LG: Unterteil aus grau lackiertem MDF mit herausnehmbaren, weiß lackierten Ablagefächer (mit plastikkappe)

CT111LT: Unterteil aus taupe lackiertem MDF mit herausnehmbaren, weiß lackierten Ablagefächer (mit plastikkappe)

Abmessung geschlossen: 110 x 70 x H39 cm      Abmessung geöffnet (1): 140 x 70 x H39 cm

Nettogewicht: 59 kg      Abmessung geöffnet (2): 140 x 100 x H39 cm

© Registriertes Modell (INPI : 20161761)

# AKANTE®

CLAUDIA®



CT194AR



CT197MA



ST194SD



CT195C



CT196SI



ST195TI



# CLAUDIA<sup>®</sup>

 Plateau : Céramique de 3 mm collée sur verre de 6 mm d'épaisseur  
ou verre clair trempé épaisseur 10 mm

Céramiques AR / MA / SD / SI / TI :

Plateau en céramique argile / marbre mat / acier / silver / titane

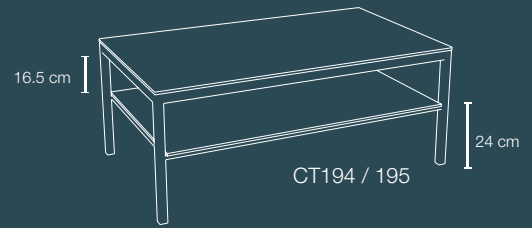

TABLE BASSE CT194 / 195 / 196 / 197

CONSOLE ST194 / 195

CT194 / 196 : Piètement : acier laqué noir mat  
CT195 / 197 : Piètement : acier inoxydable brossé

ST194 : Piètement : acier laqué noir mat  
ST195 : Piètement : acier inoxydable brossé

CT194 / 195 : Dimensions : 120 x 70 x h45 cm  
Poids Net : 45 kg

Dimensions : 100 x 38 x h75 cm  
Poids Net : 25 kg

CT196 / 197 : Dimensions : 85 x 85 x h45 cm  
Poids Net : 41 kg

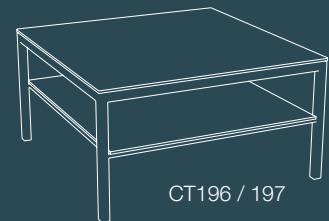

 Plate : Ceramic over glass thickness 3+6 mm  
or clear tempered glass thickness 10 mm

Ceramics AR / MA / SD / SI / TI :

Plate in ceramic argile / matt marble / steel dark / silver / titanium

COFFEE TABLE CT194 / 195 / 196 / 197

CONSOLE ST194 / 195

CT194 / 196 : Legs : Black lacquered steel  
CT195 / 197 : Legs : Brushed stainless steel

ST194 : Legs : Black lacquered steel  
ST195 : Legs : Brushed stainless steel

CT194 / 195 : Dimensions : 120 x 70 x H45 cm  
Net Weight : 45 kgs

Dimensions : 100 x 38 x H75 cm  
Net Weight : 25 kgs

CT196 / 197 : Dimensions : 85 x 85 x H45 cm  
Net Weight : 41 kgs



 **\*\*EXKLUSIVES INTERLIVING\*\***

Platte: Aus Keramik auf Glas Stärke 3+6mm  
or aus Klares Temperglas Stärke 10 mm

Keramiken AR / MA / SD / SI / TI:

Platte aus Keramik zementgrau / Marmoroptik matt / rostbraun / silber / Titan

COUCHTISCH CT194 / 195 / 196 / 197

KONSOLE ST194 / 195

CT194 / 196: Gestell: Stahl schwarz lackiert  
CT195 / 197: Gestell: Edelstahl gebürstet

ST194: Gestell: Stahl schwarz lackiert  
ST195: Gestell: Edelstahl gebürstet

CT194 / 195: Abmessung: 120 x 70 x H45 cm  
Nettogewicht: 45 kg

Abmessung: 100 x 38 x H75 cm  
Nettogewicht: 25 kg

CT196 / 197: Abmessung: 85 x 85 x H45 cm  
Nettogewicht: 41 kg



# AKANTE®

COLORADO®



# COLORADO<sup>®</sup>

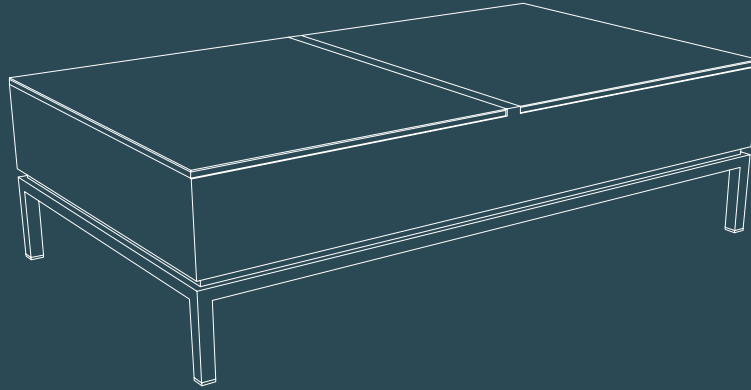

## TABLE BASSE CT251 / CT253

Structure en MDF laqué gris anthracite  
2 tablettes relevables en MDF recouvertes de céramique titane de 3 mm d'épaisseur  
Ouverture bi-directionnelle - Piètement en acier laqué noir.

Dimensions : 120 x 70 x h40 cm - Hauteur tablette déployée : 60 cm - Poids Net : 63 kg

CT251TI : Tablette de gauche déployée vers l'utilisateur, la tablette latérale s'ouvre vers la droite.

CT253TI : Tablette de droite déployée vers l'utilisateur, la tablette latérale s'ouvre vers la gauche.

© Modèle déposé (Réf. INPI : 20173908)

## COFFEE TABLE CT251 / CT253

Structure in charcoal lacquered MDF  
2 MDF adjustable trays covered with 3 mm of titanium ceramic  
Bi-directional opening - Black lacquered steel legs.

Dimensions : 120 x 70 x H40 cm - Tray height when lifted up : 60 cm - Net Weight : 63 kgs

CT251TI : Left tray opened towards user, side tray opening on the right.

CT253TI : Right tray opened towards user, side tray opening on the left.

© Registered design (ref INPI : 20173908)

## COUCHTISCH CT251 / CT253

Korpus aus anthrazitgrau lackiertem MDF  
mit 2 hochklappbaren MDF-Platten versehen mit 3 mm starker Keramik Titan  
Bidirektionelle Öffnung - Füße Stahl schwarz lackiert.

Abmessung: 120 x 70 x H40 cm - Höhe bei hochgeklappten Platten: 60 cm - Nettogewicht: 63 kg

CT251TI: Wenn linke Tischplatte zum Benutzer, öffnet sich die seitliche Tischplatte nach rechts

CT253TI: Wenn rechte Tischplatte zum Benutzer, öffnet sich die seitliche Tischplatte nach links

© Registriertes Modell (INPI : 20173908)

# AKANTE®

COMÈTE®



# COMÈTE<sup>®</sup>

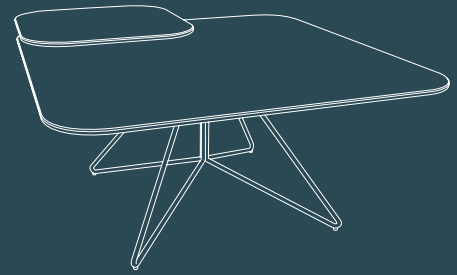

## TABLE BASSE CT345

Plateau principal et tablette en céramique collée sur verre épaisseur 3 + 6 mm

Dimension fermée : 80 x 80 x h43 cm  
Dimension ouverte : 80 x 110 x h43 cm  
Poids Net : 29 kg

CT345SD : Plateau principal en céramique acier et sa tablette en céramique argile  
CT345TI : Plateau principal en céramique titane et sa tablette en céramique marbre mat

Pieds : Acier laqué noir mat

© Modèle déposé (Réf. INPI : 20205317)

## COFFEE TABLE CT345

Main plate and tablette in ceramic over glass thickness 3 + 6 mm

Dimension closed : 80 x 80 x H43 cm  
Dimension open : 80 x 110 x H43 cm  
Net Weight : 29 kgs

CT345SD : Main plate in steel ceramic with tablette in argile ceramic  
CT345TI : Main plate in titanium ceramic with tablette in matt marble ceramic

Legs : Black lacquered steel

© Registered design (INPI : 20205317)

## COUCHTISCH CT345

Hauptplatte und Drehplatten aus Keramik auf Glas 3 + 6 mm

Abmessung geschlossen: 80 x 80 x H43 cm  
Abmessung geöffnet: 80 x 110 x H43 cm  
Nettogewicht: 29 kg

CT345SD: Hautplatte aus Keramik rostbraun und eine Drehplatte Keramik zementgrau  
CT345TI: Hautplatte aus Keramik Titan und eine Drehplatte Keramik Marmoroptik matt

Ausführungen Gestell: Stahl schwarz matt lackiert

© Registriertes Modell (INPI : 20205317)

# AKANTE®

DAHLIA®



CT287AR



CT287CC



CT287MA



CT287SD



CT287TI



CT287SI



CT287C



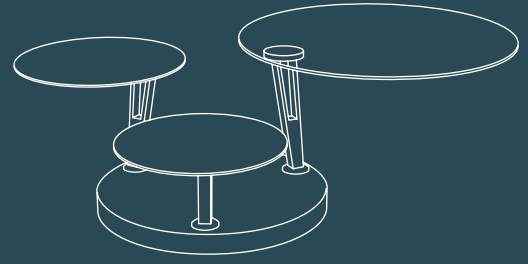

## TABLE BASSE CT287

3 plateaux synchronisés de diamètre 77, 46 et 40 cm  
Base et pieds en acier laqué noir mat (équipé de patins réglables)

Dimensions fermée : 77 cm Hauteur : 43 cm  
Dimensions ouverte : 132 cm

CT287 : Plateau supérieur : Céramique de 3 mm collée sur un verre de 6 mm épaisseur  
Plateaux inférieurs : Verre clair trempé 10 mm  
Poids Net : 69,6 kg

Céramiques AR / SD / TI / MA / SI / CC : Plateau en céramique argile / acier / titane / marbre / silver / chêne clair

© Modèle déposé (ref INPI : 20231433)

## COFFEE TABLE CT287

3 synchronised tops of diameter 77, 46 and 40 cm  
Base in black painted steel and legs in chrome steel (with built-in levellers)

Dimensions closed : 77 cm Height : 43 cm  
Dimensions open : 132 cm

CT287 : Top plate : Ceramic over glass thickness 3 + 6 mm  
Lower plates : 10 mm clear tempered glass  
Net weight : 69,6 kgs

Ceramics AR / SD / TI / MA / SI / CC : Plate in ceramic argile / steel dark / titanium / matt marble / silver / clear oak

© Registered design (INPI : 20231433)

## COUCHTISCH CT287

3 synchronisierte Platten mit Durchmesser 77, 46 und 40 cm  
Bodenplatte aus Stahlschwarz matt lackiert-Gestell aus Stahl verchromt (mit plastikcappe)

Abmessung geschlossen: 77 cm Höhe: 43 cm  
Abmessung geöffnet: 132 cm

CT287: Obere Platte: Keramik auf Glas Stärke 3 + 6 mm  
Untere Platten: Aus klarem Temperglas Stärke 10 mm  
Nettogewicht: 69,6 kg

Keramiken AR / SD / TI / MA / SI / CC: Platte aus Keramik zementgrau / rostbraun / Titan / Marmoroptik matt / silver / eiche hell

© Registriertes Modell (INPI : 20231433)

# AKANTE®

DAKOTA - KANSAS®



# DAKOTA - KANSAS®

## TABLE BASSE CT270SD / CT272SD

Structure pivotante à 360° en MDF plaqué chêne  
Piètement en acier laqué noir (équipé de patins réglables)

Dimensions fermée : 80 x 80 x h38 cm  
Hauteur déployée : 62 cm  
Poids Net : 39 kg

**DAKOTA** CT270SD  
Une tablette relevable en céramique acier  
sur MDF noir  
Dimensions ouverte : 80 x 105 x h62 cm

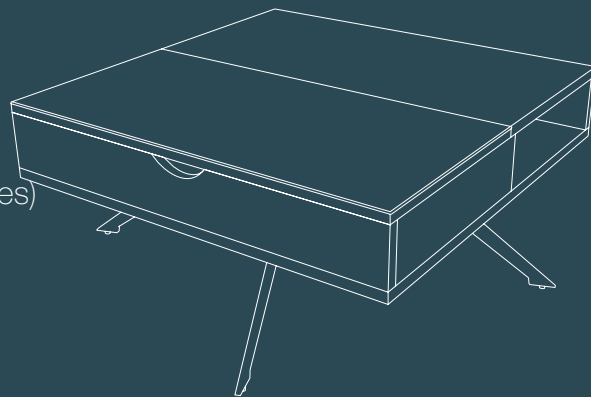

**KANSAS** CT272SD  
Deux tablettes relevables en céramique acier  
sur MDF noir  
Dimensions ouverte : 80 x 130 x h62 cm

© Modèle déposé (Réf. INPI : 20205317)

## COFFEE TABLE CT270SD / CT272SD

360° rotating structure in oak veneer  
Black epoxy painted steel legs (with built-in levellers)

Dimension closed : 80 x 80 x H38 cm  
Height lifted up : 62 cm  
Net Weight : 39 kgs

**DAKOTA** CT270SD  
One Lifting shelf in steel ceramic over black MDF  
Dimension open : 80 x 105 x H62 cm

**KANSAS** CT272SD  
Two Lifting shelves in steel ceramic  
over black MDF  
Dimension open : 80 x 130 x H62 cm

© Registered design (INPI : 20205317)

## COUCHTISCH CT270SD / CT272SD

Um 360° schwenkbarer Korpus aus MDF mit Eichefurnier  
Tischbeine aus schwarz lackiertem Stahl (mit plastikkappe)

Abmessung geschlossen: 80 x 80 x H38 cm  
Höhe bei aufgeklappter Platte: 62 cm  
Nettogewicht: 39 kg

**DAKOTA** CT270SD  
Mit einer rostbraun anhebbaren Keramikplatte  
auf schwarzem MDF  
Abmessung geöffnet: 80 x 105 x H62 cm

**KANSAS** CT272SD  
Mit zwei rostbraun anhebbaren Keramikplatten  
auf schwarzem MDF  
Abmessung geöffnet: 80 x 130 x H62 cm

© Registriertes Modell (INPI : 20205317)



# AKANTE

DOLCE VITA



# DOLCE VITA

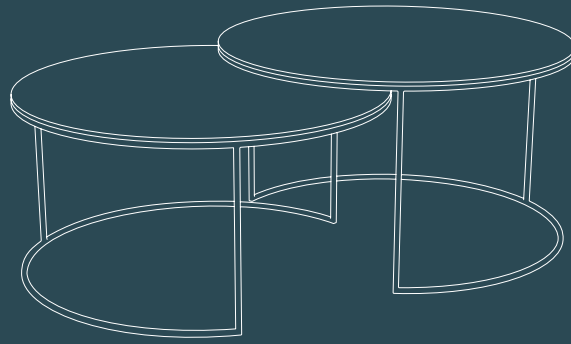

🇫🇷 Plateau : Céramique de 3 mm collée sur un verre de 6 mm  
ou en verre trempé de 10 mm disponible en plusieurs teintes.  
Piétement : Acier laqué noir mat

Céramiques AR / SD / MA / TI / SI : argile / acier / marbre mat / titane / silver

## TABLE BASSE CT460/CT462

CT460 : Dimensions : Ø 75 x h38 cm  
Poids Net : 22 kg

CT462 : Dimensions : Ø 75 x h43 cm  
Poids Net : 22 kg

## BOUT DE CANAPÉ ET460/ET462

ET460 : Dimensions : Ø 55 x h38 cm  
Poids Net : 12 kg

ET462 : Dimensions : Ø 55 x h43 cm  
Poids Net : 12 kg

🇬🇧 Top : 3 mm argile ceramic over 6 mm glass  
or 10 mm tempered glass available in several tints  
Legs : Black lacquered steel

Ceramics AR / SD / MA / TI / SI : argile / steel dark / matt marble / titanium / silver

## COFFEE TABLE CT460/CT462

CT460 : Dimensions : Ø 75 x h38 cm  
Net Weight : 22 kgs

CT462 : Dimensions : Ø 75 x h43 cm  
Net Weight : 22 kgs

## SIDE TABLE ET460/ET462

ET460 : Dimensions : Ø 55 x h38 cm  
Net Weight : 12 kgs

ET462 : Dimensions : Ø 55 x h43 cm  
Net Weight : 12 kgs

🇩🇪 3 mm Keramikplatte auf 6 mm starkem Glas oder mit 10mm starker Temperglasplatte. In verschiedenen Ausführungen erhältlich.  
Gestell: Stahl schwarz matt lackiert

Keramik AR / SD / MA / TI / SI: zementgrau / rostbraun / Marmoroptik matt / Titan / silver

## COUCHTISCH CT460/CT462

CT460 : Abmessung: Ø 75 x H38 cm  
Nettogewicht: 22 kg

CT462 : Abmessung: Ø 75 x H43 cm  
Nettogewicht: 22 kg

## BEISTELLTISCH ET460/ET462

ET460 : Abmessung: Ø 55 x H38 cm  
Nettogewicht: 12 kg

ET462 : Abmessung: Ø 55 x H43 cm  
Nettogewicht: 12 kg

# AKANTE®

DROP®



# DROP<sup>®</sup>



 BR : Plateau en acier effet bronze  
Base : Verre bouteille

## TABLE BASSE

CT380BR : Dimensions : Ø 71 x h43 cm  
Poids Net : 22 kg

## BOUT DE CANAPÉ

ET380BR : Dimensions : Ø 60 x h52 cm  
Poids Net : 18 kg

ET381BR : Dimensions : Ø 60 x h43 cm  
Poids Net : 16 kg

B1 : Plateau en acier noir  
Base : Verre gris fumé

## TABLE BASSE

CT382B1 : Dimensions : Ø 71 x h43 cm  
Poids Net : 22 kg

## BOUT DE CANAPÉ

ET382B1 : Dimensions : Ø 60 x h52 cm  
Poids Net : 18 kg

ET383B1 : Dimensions : Ø 60 x h43 cm  
Poids Net : 16 kg

© Modèle déposé (Réf. INPI : 20222320)

 BR : Top in Bronze effect steel  
Base : Green glass

## COFFEE TABLE

CT380BR : Dimensions : Ø 71 x H43 cm  
Poids Net : 22 kgs

## SIDE TABLE

ET380BR : Dimensions : Ø 60 x H52 cm  
Poids Net : 18 kgs

ET381BR : Dimensions : Ø 60 x H43 cm  
Poids Net : 16 kgs

B1 : Top in black steel  
Base : Tinted grey

## COFFEE TABLE

CT382B1 : Dimensions : Ø 71 x H43 cm  
Poids Net : 22 kgs

## SIDE TABLE

ET382B1 : Dimensions : Ø 60 x H52 cm  
Poids Net : 18 kgs

ET383B1 : Dimensions : Ø 60 x H43 cm  
Poids Net : 16 kgs

© Registered design (INPI : 20222320)

 BR: bronzefarbene Stahlplatte  
Basis: Flaschenglas

## COUCHTISCH

CT380BR: Dimensions: Ø 71 x H43 cm  
Poids Net: 22 kg

## BEISTELLTISCH

ET380BR: Dimensions: Ø 60 x H52 cm  
Poids Net: 18 kg

ET381BR: Dimensions: Ø 60 x H43 cm  
Poids Net: 16 kg

B1: Platte aus schwarzem Stahl  
Basis: Rauchgraues Glas

## COUCHTISCH

CT382B1: Dimensions: Ø 71 x H43 cm  
Poids Net: 22 kg

## BEISTELLTISCH

ET382B1: Dimensions: Ø 60 x H52 cm  
Poids Net: 18 kg

ET383B1: Dimensions: Ø 60 x H43 cm  
Poids Net: 16 kg

© Registriertes Modell (INPI : 20222320)

# AKANTE®

EMMA

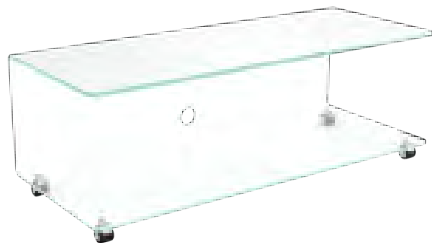

# EMMA

🇫🇷 Verre Cristallin courbé à chaud épaisseur 12 mm. Roulettes équipées de freins.

## COIN CANAPÉ

Dimensions : 42 x 42 x 49 cm

Poids Net : 16 kg

ET073R

## MEUBLE TV

Dimensions : 120 x 42 x 42 cm

Poids Net : 51 kg

TV003R

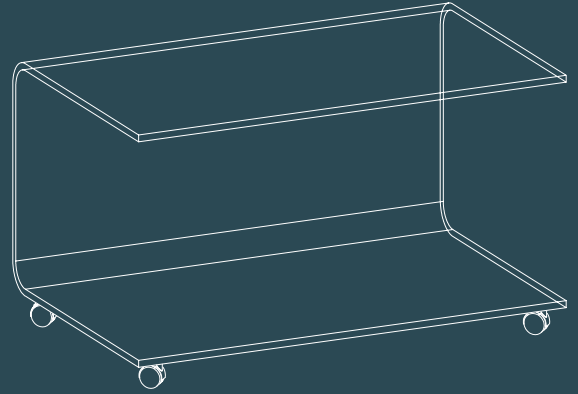

🇬🇧 Hot bent Crystal glass\* thickness 12 mm. Wheel with caster brakes.

## END TABLE

Dimensions : 42 x 42 x 49 cm

Net Weight : 16 kgs

ET073R

## TV SET

Dimensions : 120 x 42 x 42 cm

Net Weight : 51 kgs

TV003R

🇩🇪 Glas hitzegebogen, ultraklar. Materialstärke 12 mm. Rollen mit Bremsen ausgestattet.

## BEISTELLTISCH

Abmessung: 42 x 42 x 49 cm

Nettogewicht: 16 kg

ET073R

## TV MEDIAMÖBEL

Abmessung: 120 x 42 x 42 cm

Nettogewicht: 51 kg

TV003R

# AKANTE®

ENIGMA®



# ENIGMA<sup>®</sup>

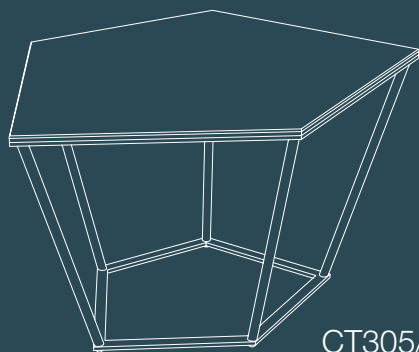

CT305/306

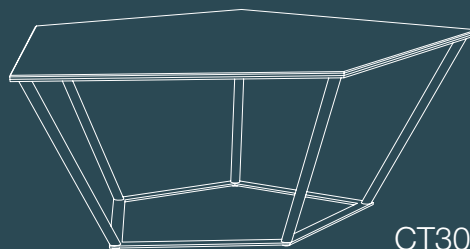

CT307

## TABLE BASSE

Plateau supérieur : Céramique sur verre épaisseur 3 + 6 mm - Plateau céramique titane  
Pieds : Acier peinture epoxy noir mat

CT305TI : Dimensions 72 x 54 x h38 cm - Poids Net : 15 kg

CT306TI : Dimensions 72 x 54 x h48 cm - Poids Net : 16 kg

CT307TI : Dimensions 110 x 83 x h38 cm - Poids Net : 24 kg

© Modèle déposé (ref INPI : 20190743)

## COFFEE TABLE

Top plate : Ceramic over glass thickness 3 + 6 mm - Titanium ceramic top  
Black epoxy painted steel legs

CT305TI : Dimensions 72 x 54 x H38 cm - Net Weight : 15 kgs

CT306TI : Dimensions 72 x 54 x H48 cm - Net Weight : 16 kgs

CT307TI : Dimensions 110 x 83 x H38 cm - Net Weight : 24 kgs

© Registered design (INPI : 20190743)

## COUCHTISCH

3 mm Keramikplatte auf 6 mm Glas - Keramikplatte Titan  
Tischfüße: Edelstahl schwarz lackiert matt

CT305TI: Abmessung 72 x 54 x H38 cm - Nettogewicht: 15 kg

CT306TI: Abmessung 72 x 54 x H48 cm - Nettogewicht: 16 kg

CT307TI: Abmessung 110 x 83 x H38 cm - Nettogewicht: 24 kg

© Registriertes Modell (INPI : 20190743)



# AKANTE®

ENORA - ENORA LAQUÉE®

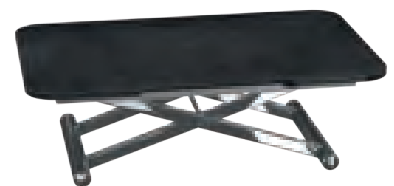

# ENORA - ENORA LAQUÉE<sup>®</sup>

## TABLE BASSE

Plateau supérieur en céramique de 3 mm collé sur un verre de 8 mm d'épaisseur.  
Hauteur ajustable de 38 à 82 cm  
2 rallonges rétractables de façon indépendante

Dimensions : 120/190 x 75 x h38/82 cm  
Poids net : 59 kg

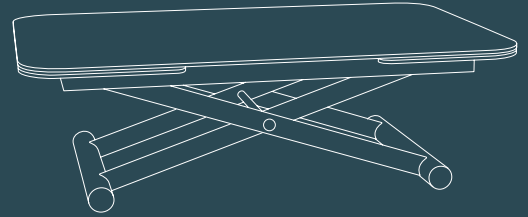

### CT200MA / AR :

Plateau en céramique marbre mat / argile - Piétement : Acier inoxydable poli

### CT204AR :

Plateau en céramique argile - Piétement acier gris perle mat

CT205SI / SD / TI / CC : Plateau en céramique silver / acier / titane / chêne clair  
Piétement acier laqué noir mat

CT206MA : Plateau en céramique marbre mat - Piétement acier laqué blanc mat

## COFFEE TABLE

Top in ceramic over glass 3 + 8 mm  
Adjustable height from 38 to 82 cm  
Two pull-out extensions

Dimensions : 120/190 x 75 x H38/82 cm  
Net weight: 59 kgs

### CT200MA / AR :

Tops in ceramic matt marble / argile - Legs : Polished stainless steels

### CT204AR :

Top in ceramic argile - Legs in pearl grey lacquered steel

CT205SI / SD / TI / CC : Top in ceramic silver / steel / titan / clear oak  
Legs in black lacquered steel

CT206MA : Top in ceramic matt marble - Legs in white lacquered steel

## COUCHTISCH

Obere Platte aus Keramik auf Glas Stärke 3 + 8 mm  
Höhenverstellbar von 38 auf 82 cm  
Von einander unabhängig einziehbare Verlängerungen

Abmessung: 120/190 x 75 x H38/82 cm  
Nettogewicht: 59 kg

### CT200MA / AR / SD / TI / SI / CC:

Obere Platte aus Keramik Marmoroptik matt / zementgrau - Gestell: Edelstahl glanz poliert

### CT204AR:

Obere Platte aus Keramik Zementgrau - Gestell aus Stahl perlgrau lackiert

CT205SI / SD / TI / CC: Obere Platte aus Keramik Silber / Rostbraune / Titan / eiche hell  
Gestell aus Stahl schwarz matt lackiert

### CT206MA:

Obere Platte aus Keramik Marmoroptik matt - Gestell aus Stahl weiß lackiert

© Registriertes Modell (INPI : 20161761)

# AKANTE®

EOLIA



# EOLIA

## TABLE BASSE CT125 / CT225 / CT325 / CT326

Dimension fermée : Ø 75 x 41,5 cm  
Dimension ouverte : 130 x 75 x 41,5 cm  
Poids Net : 45 kg

CT125 / CT326 : Structure en acier chromé  
CT225 / CT325 : Structure en acier laqué noir mat

Plateau supérieur :

Céramique de 3 mm collée sur un verre de 6 mm d'épaisseur, couleurs : Argile (AR), Marbre Mat (MA), Acier (SD), Silver (SI), Titane (TI) Chêne Clair (CC)

Verre trempé de 10 mm, couleur : Clair (C), Gris Fumé (G)

Plateau inférieur : Verre trempé ou céramique (équipé de patins réglables)

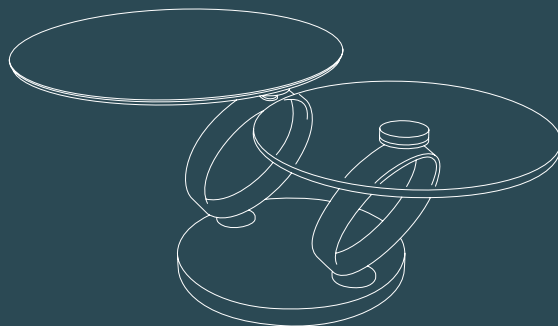

## COFFEE TABLE CT125 / CT225 / CT325 / CT326

Dimension closed : Ø 75 x 41,5 cm  
Dimension open : 130 x 75 x 41,5 cm  
Net Weight : 45 kgs

CT125 / CT326 : Structure in chrome steel  
CT225 / CT325 : Structure in mat black painting steel

Top plate :

Ceramic over glass thickness 3 + 6 mm, colours : Argile (AR), Matt marble (MA), Steel dark (SD), Silver (SI), Titanium (TI), Clear oak (CC)

10 mm tempered glass, colours : Clear glass (C), Smoked grey glass (G)

Lower plate : tempered glass or ceramic (with built-in levellers)

## COUCHTISCH CT125 / CT225 / CT325 / CT326

Abmessung geschlossen: Ø 75 x 41,5 cm  
Abmessung geöffnet: 130 x 75 x 41,5 cm  
Nettogewicht: 45 kg

CT125 / CT326: Gestell aus verchromtem Stahl  
CT225 / CT325: Gestell aus Stahl schwarz matt lackiert

Tischplatte:

Keramik auf Glas Stärke 3 + 6 mm, farben: zementgrau (AR), Marmoroptik matt (MA), rostbraun (SD), silver (SI), Titan (TI), eiche hell (CC)

10 mm starkem Temperglas, farben: Glas Klar (C), Glas grau getönt (G)

Untere Platte: Temperglas Stärke oder Keramik (mit plastikcappe)

# AKANTE®

EURÉKA®



# EURÉKA®

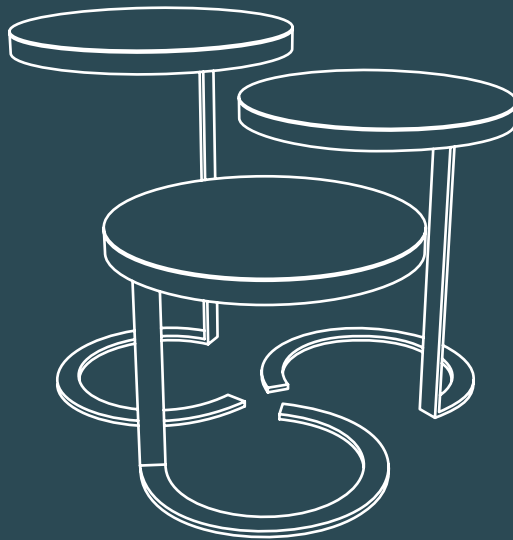

## COIN CANAPE

Structure en acier laqué noir  
Plateau en céramique sur MDF laqué noir  
AR / MA / SD / TI :  
Plateau en céramique argile / marbre mat / acier / titane

### ET225

Dimension : Ø 40 x h35 cm  
Poids Net : 12 kg

### ET226

Dimension : Ø 40 x h45 cm  
Poids Net : 12,5 kg

### ET227

Dimension : Ø 40 x h55 cm  
Poids Net : 13 kg

## SIDE TABLE

Black matt lacquered steel structure  
Top plate in ceramic over black lacquered MDF :  
AR / MA / SD / TI :  
Top in ceramic argile / matt marble ceramic / steel / titanium ceramic

### ET225

Dimension : Ø 40 x H35 cm  
Net Weight : 12 kgs

### ET226

Dimension : Ø 40 x H45 cm  
Net Weight : 12,5 kgs

### ET227

Dimension : Ø 40 x H55 cm  
Net Weight : 13 kgs

## BEISTELLTISCH

Gestell: Stahl schwarz lackiert  
Keramikplatte auf schwarz lackiertem MDF  
AR / MA / SD / TI:  
Keramikplatte zementgrau / Marmoroptik matt / rostbraun / Titan

### ET225

Abmessung: Ø 40 x H35 cm  
Nettogewicht: 12 kg

### ET226

Abmessung: Ø 40 x H45 cm  
Nettogewicht: 12,5 kg

### ET227

Abmessung: Ø 40 x H55 cm  
Nettogewicht: 13 kg

# AKANTE®

GALET®



# GALET<sup>®</sup>

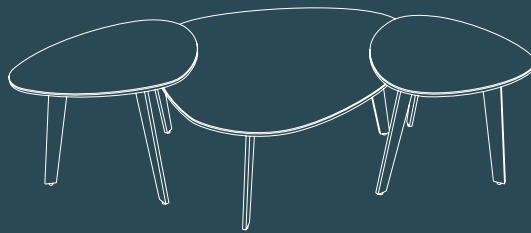

Plateau supérieur :

Céramique de 3 mm collée sur un verre de 6 mm d'épaisseur, couleurs : Argile (AR), Marbre Mat (MA), Acier (SD), Silver (SI), Titane (TI), Chêne clair (CC)

Céramique pleine masse de 11 mm, couleurs : Marquina (MM), Calcatta (MC), Onyx bleu (MO)

Verre feuilleté avec maille d'acier épaisseur 10 mm (MB)

Plètement : Acier laqué noir mat (équipé de patins réglables)

## TABLE BASSE

Pieds pleins : CT214 / CT215 / CT216 / CT224  
Pieds ajourés : CT414 / CT415 / CT416 / CT424

Dimensions : 92 x 76 x h33 cm  
h38 cm  
h43 cm  
h50 cm

Poids Net : 19 kg

## COIN CANAPÉ

Pieds pleins : ET214 / ET215 / ET216 / ET224  
Pieds ajourés : ET414 / ET415 / ET416 / ET424

Dimensions : 55 x 45 x h33 cm  
h38 cm  
h43 cm  
h50 cm

Poids Net : 12 kg

© Modèle déposé (Réf. INPI : 20190743)



Top plate :

Ceramic over glass thickness 3 + 6 mm, colours : Argile (AR), Matt marble (MA), Steel dark (SD), Silver (SI), Titanium (TI), Clear oak (CC)

Full body ceramic thickness 11 mm, colours : Marquina (MM), Calcatta (MC), Onyx bleu (MO)

Laminated glass with steel mesh thickness 10 mm (MB)

Legs : Black lacquered steel (with built-in levellers)

## COFFEE TABLE

Solid legs : CT214 / CT215 / CT216 / CT224  
Open-style legs : CT414 / CT415 / CT416 / CT424

Dimensions : 92 x 76 x H33 cm  
H38 cm  
H43 cm  
H50 cm

Net weight : 19 kgs

## END TABLE

Solid legs : ET214 / ET215 / ET216 / ET224  
Open-style legs : ET414 / ET415 / ET416 / ET424

Dimensions : 55 x 45 x H33 cm  
H38 cm  
H43 cm  
H50 cm

Net weight : 12 kgs

© Registered design (INPI : 20190743)



Tischplatte:

Keramik auf Glas Stärke 3 + 6 mm, farben: zementgrau (AR), Marmoroptik matt (MA), rostbraun (SD), silver (SI), Titan (TI), eiche hell (CC)

11 mm dicke Vollkeramik, farben: Marquina (MM), Calcatta (MC), Onyx bleu (MO)

Verbundglas mit integriertem Stahlgeflecht Stärke 10 mm (MB)

Gestell: Stahl schwarz matt lackiert (mit plastikkappe)

## COUCHTISCH

Tischbeine ganz: CT214 / CT215 / CT216 / CT224  
Oder durchbrochen: CT414 / CT415 / CT416 / CT424

Abmessung: 92 x 76 x H33 cm  
H38 cm  
H43 cm  
H50 cm

Nettogewicht: 19 kg

## BEISTELLTISCH

Tischbeine ganz: ET214 / ET215 / ET216 / ET224  
Oder durchbrochen: ET414 / ET415 / ET416 / ET424

Abmessung : 55 x 45 x H33 cm  
H38 cm  
H43 cm  
H50 cm

Nettogewicht : 12 kg

© Registriertes Modell (INPI : 20190743)



# AKANTE®

GALICE

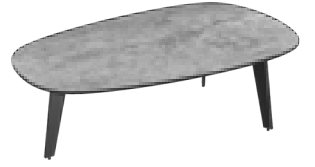
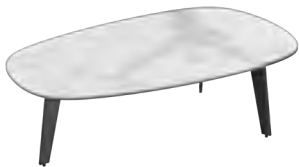

# GALICE

## TABLE BASSE

CT217 / CT417

Pieds : Acier peinture epoxy noir mat (équipé de patins réglables)

Pieds pleins : CT217

Pieds ajourés : CT417

Dimensions : 100 x 60 x h33 cm

Poids Net : 20 kg

Plateau :

Céramique de 3 mm collée sur un verre de 6 mm d'épaisseur, couleurs : Argile (AR), Marbre Mat (MA), Acier (SD), Silver (SI), Titane (TI), Chêne clair (CC)

Céramique pleine masse de 11 mm, couleurs : Marquina (MM), Calcatta (MC), Onyx bleu (MO)

Disponible en hauteur 38 cm, 43 cm et 50 cm

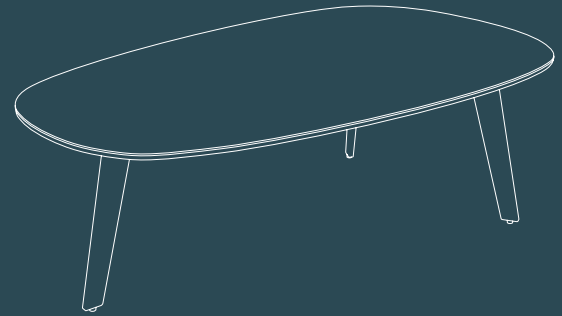

## COFFEE TABLE

CT217 / CT417

Legs : Black epoxy painted steel (with built-in levellers)

Solid legs : CT217

Open-style legs : CT417

Dimensions : 100 x 60 x H33 cm

Net weight : 20 kgs

Top :

Ceramic over glass thickness 3 + 6 mm, colours : Argile (AR), Matt marble (MA), Steel dark (SD), Silver (SI), Titanium (TI), Clear oak (CC)

Full body ceramic thickness 11 mm, colours : Marquina (MM), Calcatta (MC), Onyx blue (MO)

Available in 38 cm, 43 cm and 50 cm.

## COUCHTISCH

CT217 / CT417

Füße : Stahl pulverbeschichtet schwarz matt (mit plastikkappe)

Tischbeine ganz: CT217

Oder durchbrochen: CT417

Abmessung: 100 x 60 x H33 cm

Nettogewicht: 20 kg

Tischplatte:

Keramik auf Glas Stärke 3 + 6 mm, farben: zementgrau (AR), Marmoroptik matt (MA), rostbraun (SD), silver (SI), Titan (TI), eiche hell (CC)

11 mm dicke Vollkeramik, farben: Marquina (MM), Calcatta (MC), Onyx blau (MO)

Erhältlich in den Höhen 38 cm, 43 cm und 50 cm.

# AKANTE®

GENOA®



# GENOA<sup>®</sup>

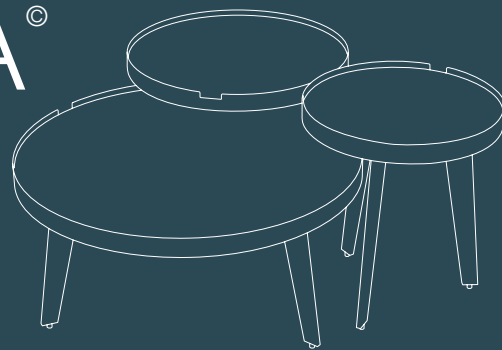

 Plateau supérieur :  
Céramique pleine masse de 11 mm, couleurs : Marquina (MM), Calcatta (MC), Onyx bleu (MO), Emperador (ME)  
Ceinture acier effet laiton ou acier laqué noir de 4 cm de hauteur

Piètement : Acier laqué noir mat (équipé de patins réglables)

## TABLE BASSE

Pieds pleins : CT504 / CT539

Pieds ajourés : CT604 / CT639

Dimensions : Ø 70 x h33 cm  
h38 cm  
h43 cm  
h50 cm

Poids Net : 15,5 kg

## BOUT DE CANAPÉ

Pieds pleins : ET504 / ET551 / ET539 / ET546

Pieds ajourés : ET604 / ET651 / ET639 / ET646

Dimensions : Ø 50 ou Ø 40 x h33 cm  
h38 cm  
h43 cm  
h50 cm

Poids Net : 10 kg

© Modèle déposé (Réf. INPI : 20222320)

 Top plate :  
Full body ceramic thickness 11 mm, colours : Marquina (MM), Calcatta (MC), Onyx blue (MO), Emperador (ME)

Steel frame with brass effect or black laquered steel, Height 4 cm

Legs : Black lacquered steel (with built-in levellers)

## COFFEE TABLE

Solid legs : CT504 / CT539

Open-style legs : CT604 / CT639

Dimensions : Ø 70 x H33 cm  
H38 cm  
H43 cm  
H50 cm

Net weight : 15,5 kgs

## SIDE TABLE

Solid legs : ET504 / ET551 / ET539 / ET546

Open-style legs : ET604 / ET651 / ET639 / ET646

Dimensions : Ø 50 ou Ø 40 x H33 cm  
H38 cm  
H43 cm  
H50 cm

Net weight : 10 kgs

© Registered design (INPI : 20222320)

 Tischplatte:  
11 mm dicke Vollkeramik, farben: Marquina (MM), Calcatta (MC), Onyx blau (MO), Emperador (ME)

Messingfarbener Stahlgürtel oder schwarz lackierter Stahl mit 4 cm Höhe

Gestell: Stahl schwarz matt lackiert (mit plastikkappe)

## COUCHTISCH

Tischbeine ganz: CT504 / CT539

Oder durchbrochen: CT604 / CT639

Abmessung: Ø 70 x H33 cm  
H38 cm  
H43 cm  
H50 cm

Nettogewicht: 15,5 kg

## BEISTELLTISCH

Tischbeine ganz: ET504 / ET551 / ET539 / ET546

Oder durchbroche: ET604 / ET651 / ET639 / ET646

Abmessung: Ø 50 ou Ø 40 x H33 cm  
H38 cm  
H43 cm  
H50 cm

Nettogewicht: 10 kg

© Registriertes Modell (INPI : 20222320)

# AKANTE®

GRANADA®



# GRANADA<sup>®</sup>

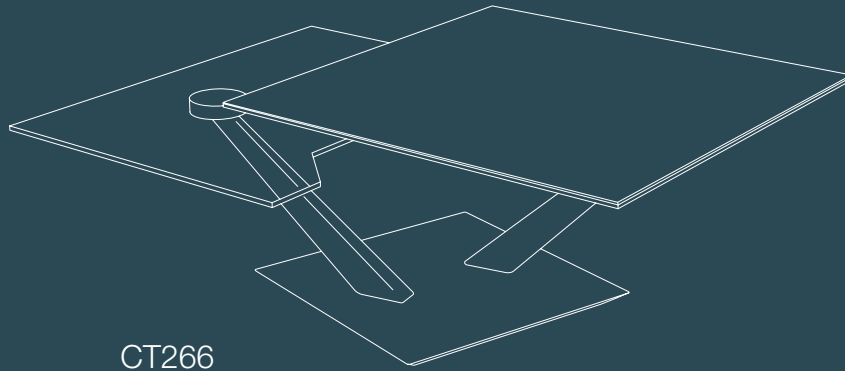

## TABLE BASSE

CT266

Plateau supérieur à mécanisme synchronisé en céramique de 3 mm collé sur un verre de 6 mm  
Plateau inférieur en verre trempé de 10 mm  
Piétement : Acier laqué noir mat

Dimensions fermée : 80 x 80 x h40 cm  
Dimensions ouverte : 127 x 80 x h40 cm  
Poids Net : 52 kg

CT266SI / AR / MA / MM / SD / TI / CC :

Plateau céramique silver / argile / marbre mat / marbre marquina / acier / titane / chêne clair

© Modèle déposé (Réf. INPI : 20215513)

## COFFEE TABLE

CT266

Main plate with synchronized system in ceramic over glass thickness 3 + 6 mm  
Tempered glass second plate 10 mm  
Legs : Black lacquered steel

Dimensions closed : 80 x 80 x H40 cm  
Dimensions open : 127 x 80 x H40 cm  
Net Weight : 52 kgs

CT266SI / AR / MA / MM / SD / TI / CC :

Ceramic plate silver / argile / marble matt / marquina marble / steel dark / titanium / clear oak

© Registered design (INPI : 20215513)

## COUCHTISCH

CT266

Obere Platte aus 3 mm Keramik verklebt auf 6 mm starkem Glas mit synchronisiertem Mechanismus.  
Untere Platte aus 10 mm starkem Temperglas.  
Gestell aus schwarz matt lackiertem Stahl

Abmessung geschlossen: 80 x 80 x H40 cm  
Abmessung geöffnet: 127 x 80 x H40 cm  
Nettogewicht: 52 kg

CT266SI / AR / MA / MM / SD / TI / CC :

Ausführungen der Keramikplatte: silver / zementgrau / Marmoroptik matt / Marmoroptik Marquina / rostbraun / Titan / eiche hell

© Registriertes Modell (INPI : 20215513)

# AKANTE®

HÉLICE - SAFRAN®



CT172AR



CT172MA



CT172SD



CT170C



CT170SI



CT170TI



# HÉLICE - SAFRAN<sup>®</sup>

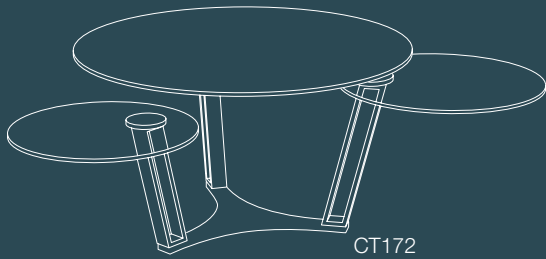

CT172

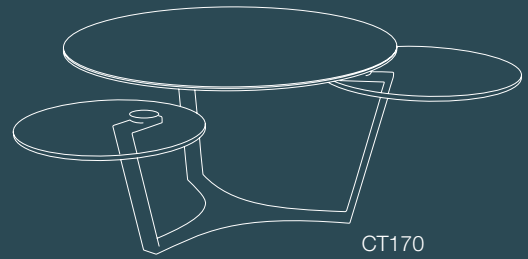

CT170

## TABLE BASSE CT172 / CT170

Plateau supérieur en céramique de 3 mm collé sur un verre de 6 mm  
Plateaux inférieurs synchronisés en verre trempé de 10 mm  
Piétement : Acier peinture noire époxy

Dimensions fermée : Ø 77 x h43 cm  
Poids Net : 55 kg

Dimensions ouverte : Ø 115 x 84 x h43 cm

Céramiques AR / SD / TI / MA / SI / CC :

Plateau supérieur en céramique argile / acier / titane / marbre mat / silver / chêne clair

CT172 / 170CH : Plateau supérieur en MDF plaqué chêne

CT172 / 170C : Plateau supérieur en verre trempé de 10 mm

© Modèle déposé (Réf. INPI : 20215513)

## COFFEE TABLE CT172 / CT170

Main plate in ceramic over glass thickness 3 + 6 mm  
Synchronized second plates in tempered glass 10 mm  
Legs : Black epoxy painted steel

Closed dimensions : Ø 77 x H43 cm  
Net Weight : 55 kgs

Open dimenisons : Ø 115 x 84 x H43 cm

Ceramics AR / SD / TI / MA / SI / CC :

Main plate in ceramic argile / steel dark / titanium / matt marble / silver / clear oak

CT172 / 170CH : Main plate in MDF oak veneer

CT172 / 170C : Main plate in 10 mm tempered glass

© Registered design (INPI : 20215513)

## COUCHTISCH CT172 / CT170

Obere Platte aus 3 mm Keramik verklebt auf 6 mm starkem Glas  
Untere synchronisierte Platten aus 10 mm starkem Temperglas  
Gestell: Stahl pulverbeschichtet schwarz

Abmessung geschlossen: Ø 77 x H43 cm  
Nettogewicht: 55 kg

Abmessung geöffnet: Ø 115 x 84 x H43 cm

Keramik AR / SD / TI / MA / SI / CC:

Ausführungen der Keramikplatte: zementgrau / rostbraun / Titan / Marmoroptik matt / silver / eiche hell

CT172 / 170CH: Obere Platte aus MDF mit Eichenfurnier

CT172 / 170C: Obere Platte aus 10 mm starkem Temperglas

© Registriertes Modell (INPI : 20215513)



# AKANTE®

IRIS®



# IRIS<sup>®</sup>



🇫🇷 Plateau supérieur : Céramique de 3 mm collée sur un verre de 6 mm d'épaisseur.  
Piétement : Acier laqué noir

**TABLE BASSE** CT320SI  
Céramique **SI** : Silver  
Dimensions : Ø 75 x h40 cm Poids Net : 15 kg

**COIN CANAPÉ** ET310  
Dimensions : Ø 55 x h50 cm Poids Net : 12 kg  
**ET310AR / SD / SI / MA / TI / CC :**  
Céramique argile / acier / silver / marbre / titane / chêne clair

© Modèle déposé (Réf. INPI : 20200478)

🇬🇧 Top plate : Ceramic over glass 3 + 6 mm. Black epoxy painted steel legs.

**COFFEE TABLE** CT320SI  
Ceramic **SI** : Silver  
Dimensions : Ø 75 x H40 cm Net weight : 15 kgs

**END TABLE** ET310  
Dimensions : Ø 55 x H50 cm Net Weight : 12 kgs  
**ET310AR / SD / SI / MA / TI / CC :**  
Tops in ceramic argile / steel dark / silver / matt marble / titanium / clear oak

© Registered design (INPI : 20200478)

🇩🇪 Oberplatte Keramik auf Glas, 3 + 6 mm. Gestell aus schwarz lackiertem Stahl.

**COUCHTISCH** CT320SI  
Keramik **SI**: Silver  
Abmessung: Ø 75 x H40 cm Nettogewicht : 15 kg

**BEISTELLTISCH** ET310  
Abmessung: Ø 55 x H50 cm Nettogewicht: 12 kg

**ET310AR / SD / SI / MA / TI / CC:**  
Obere Platte aus Keramik zementgrau / rostbraun / silver / Marmoroptik Matt / Titan / eiche hell

© Registriertes Modell (INPI: 20200478)

# AKANTE®

JULIA

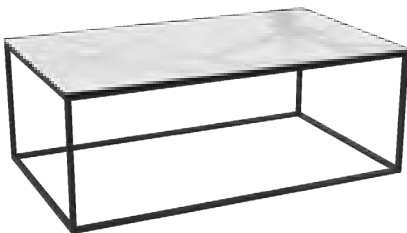

# JULIA

 Vaste choix de finitions pour le plateau supérieur

CT / ST / ET180 : Structure en acier peinture epoxy noir mat  
CT / ST / ET182 : Structure en acier inoxydable brossé

**TABLE BASSE** CT180/182  
Dimensions : 110 x 65 x h40 cm Poids Net : 18 kg

**COIN CANAPÉ** ET180/182  
Dimensions : 50 x 50 x h50 cm Poids Net : 8 kg

**CONSOLE** ST180/182  
Dimensions : 100 x 38 x h80 cm Poids Net : 13 kg

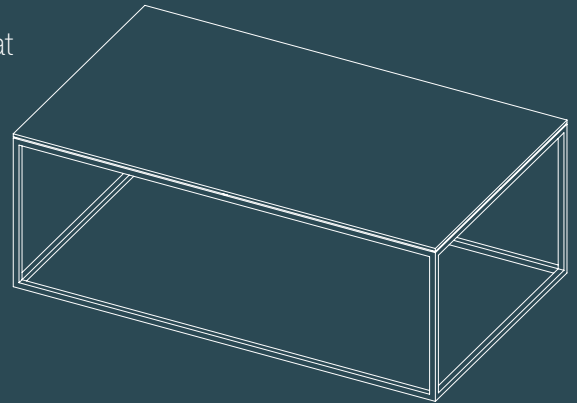

CT180

 Large choice of finishes for tops

CT / ST / ET180 : Black epoxy painted steel structure  
CT / ST / ET182 : Brushed stainless steel structure

**COFFEE TABLE** CT180/182  
Dimensions : 110 x 65 x H40 cm Net Weight : 18 kgs

**END TABLE** ET180/182  
Dimensions : 50 x 50 x H50 cm Net Weight : 8 kgs

**CONSOLE TABLE** ST180/182  
Dimensions : 100 x 38 x H80 cm Net Weight : 13 kgs

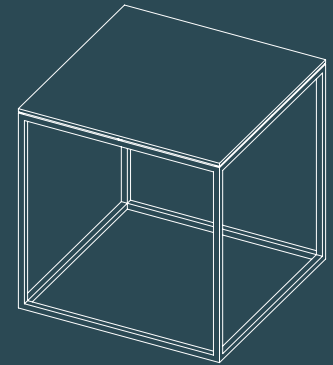

ET180

 Große Auswahl an Ausführungen für die oberen Tischplatte

CT / ST / ET180: Gestell aus Edelstahl, schwarz pulverbeschichtet  
CT / ST / ET182: Gestell aus gebürstetem Edelstahl

**COUCHTISCH**  
Abmessung: 110 x 65 x H40 cm Nettogewicht: 18 kg

**BEISTELLTISCH**  
Abmessung: 50 x 50 x H50 cm Nettogewicht: 8 kg

**KONSOLE**  
Abmessung: 100 x 38 x H80 cm Nettogewicht: 13 kg

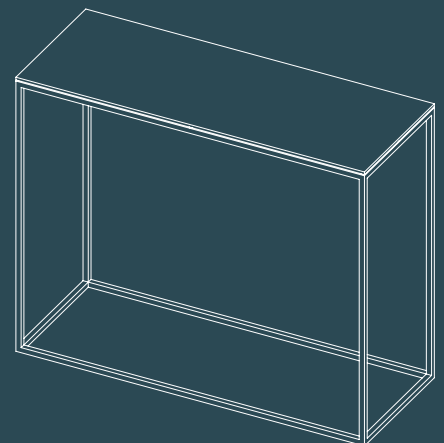

ST180

# AKANTE®

JULIA AVEC ÉTAGÈRE  
PETITE CONSOLE JULIA



Céramique SD

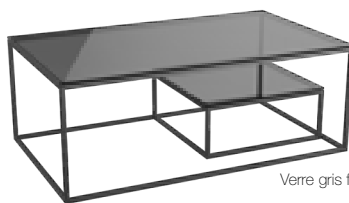

Verre gris fumé G

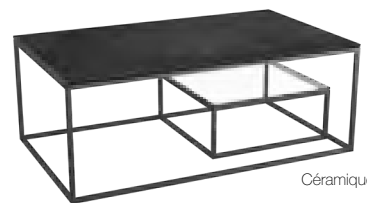

Céramique T1



Céramique S1



Céramique T1



Céramique AR



# JULIA



## TABLE BASSE

CT310

Vaste choix de finitions pour le plateau supérieur et inférieur  
Structure en acier peinture epoxy noir mat  
Dimensions : 110 x 65 x 40 cm  
Plateau inférieur : 50 x 50 cm  
Poids Net : 33 kg

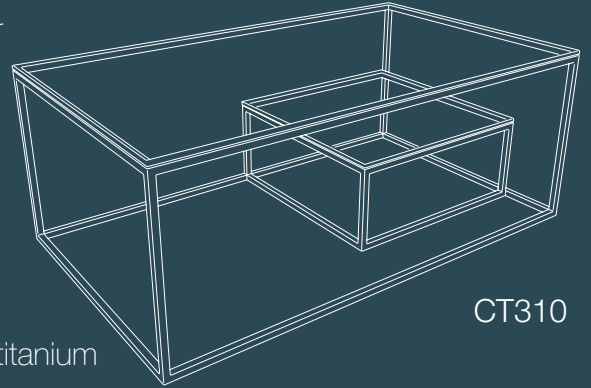

CT310

## PETITE CONSOLE

SH006

SH006AR / MA / SD / SI / TI  
Plateaux en céramique argile / marbre mat / acier / silver / titanium  
Structure en acier peinture epoxy noir  
Dimensions : 90 x 30 x h90 cm  
Poids Net : 11 kg



## COFFEE TABLE

CT310

Large choice of finishes for top and shelf  
Structure : black painted epoxy steel  
Dimensions : 110 x 65 x 40 cm  
Lower top : 50 x 50 cm  
Net Weight : 33 kgs

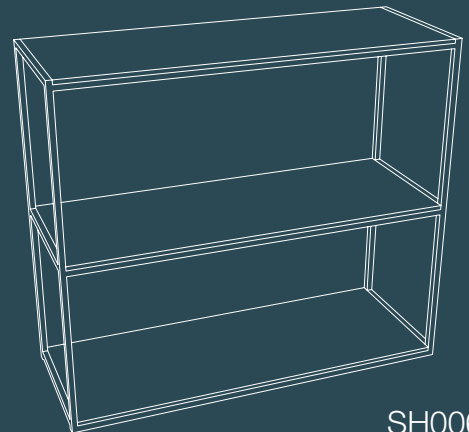

SH006

## LITTLE CONSOLE

SH006

SH006AR / MA / SD / SI / TI  
Plates in argile / matt marble / acier / silver / titanium  
Structure : black painted epoxy steel  
Dimension : 90 x 30 x H90 cm  
Net Weight : 11 kgs



## COUCHTISCH

CT310

Große Auswahl für die obere und untere Platte  
Gestell Stahl pulverbeschichtet schwarz matt  
Abmessung: 110 x 65 x 40 cm  
Untere Platte: 50 x 50 cm  
Nettogewicht: 33 kg

## KLEINE KONSOLE

SH006

SH006AR / MA / SD / SI / TI  
Keramikplatten-Ausführungen in zementgrau / Marmoroptik weiß matt / rostbraun / silver / Titan  
Gestell Stahl pulverbeschichtet schwarz matt  
Abmessung: 90 x 30 x h90 cm  
Nettogewicht: 11 kg

# AKANTE®

KINGSTON®



CT420/ET420



CT422/ET422



# KINGSTON<sup>®</sup>



 Pieds : Acier peinture epoxy noir mat

**CT420 / ET420 :**

Plateau supérieur pivotant en céramique marbre brillant 5 mm collée sur un MDF plaqué noyer  
Caisson en MDF plaqué noyer

**TABLE BASSE**      **CT420 / CT422TI**

Dimensions : Ø 85 x h40 cm  
Poids Net : 39 kg

**CT422TI / ET422TI :**

Plateau supérieur pivotant en céramique titane de 3 mm collée sur un MDF plaqué chêne  
Caisson en MDF plaqué chêne

**COIN CANAPÉ**      **ET420 / ET422TI**

Dimensions : Ø 44 x h52 cm  
Poids Net : 10 kg

© Modèle déposé (Réf. INPI : 20190743)

 Legs : Black epoxy painted steel

**CT420 / ET420 :**

Pivoting top plate in 5 mm shiny marble ceramic over walnut veneer MDF  
Body in walnut veneer MDF

**COFFEE TABLE**      **CT420/CT422TI**

Dimensions : Ø 85 x h40 cm  
Net Weight : 39 kgs

**CT422TI / ET422TI :**

Pivoting top plate in 3 mm titanium ceramic over oak veneer MDF  
Body in oak veneer MDF

**END TABLE**      **ET420/ET422TI**

Dimensions : Ø 44 x h52 cm  
Net Weight : 10 kgs

© Registered design (INPI : 20190743)

 Gestell: Stahl pulverbeschichtet schwarz matt

**CT420 / ET420:**

Obere Platte drehbar aus 5 mm dicker Keramik in glänzender Marmoroptik auf MDF mit Nussbaumfurnier  
Korpus aus MDF mit Nussbaumfurnier

**COUCHTISCH**      **CT420/CT422TI**

Abmessung: Ø 85 x H40 cm  
Nettogewicht: 39 kg

**CT422TI / ET422TI:**

Obere Platte drehbar aus 3 mm Titan Keramik auf MDF mit Eiche  
Korpus aus MDF mit Eiche

**BEISTELLTISCH**      **ET420/ET422TI**

Abmessung: Ø 44 x H52 cm  
Nettogewicht: 10 kg

© Registriertes Modell (INPI 20190743)



# AKANTE®

LILI - TULSA - EVA



# LILI - TULSA - EVA

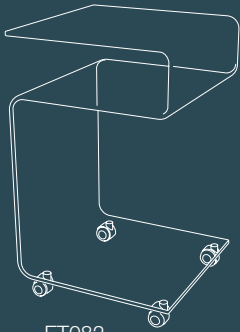

ET082

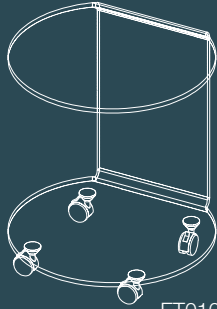

ET010



ET065

## COIN CANAPE ET082 / ET010

Verre courbé à chaud haute résistance

Épaisseur : 12 mm  
Roulettes équipées de freins.

ET082 : Dimensions : 40 x 40 x h69 cm  
Poids Net : 22 kg

ET010 : Dimensions : 50 x 50 x h58 cm  
Poids Net : 16 kg

## COIN CANAPÉ ET065

Verre courbé à chaud haute résistance

Épaisseur : 12 mm  
Dimensions : 45 x 31.5 x h66 cm  
Poids Net : 14 kg

ET065G : Verre gris fumé  
ET065F : Verre clair  
ET065R : Verre cristallin

## END TABLE ET082 / ET010

High resistance hot bent glass

Thickness : 12 mm  
Wheels with caster brakes.

ET082 : Dimensions : 40 x 40 x H69 cm  
Net Weight : 22 kgs

ET010 : Dimensions : 50 x 50 x H58 cm  
Net Weight : 16 kgs

## SIDE TABLE ET066

High resistance hot bent tempered glass

Thickness : 12 mm  
Dimensions : 45 x 31.5 x H66 cm  
Net Weight : 14 kgs

ET066G : Grey tinted glass  
ET066 : Clear glass  
ET066R : Crystal\* glass

\*Low iron glass

## BEISTELLTISCH ET082 / ET010

Glas hitzegebogen, hochresistent

Materialstärker: 12 mm  
Rollen mit Bremsen ausgestattet.

ET082: Abmessung: 40 x 40 x H69 cm  
Nettogewicht: 22 kg

ET010: Abmessung: 50 x 50 x H58 cm  
Nettogewicht: 16 kg

## BEISTELLTISCH ET065

Hochresistentes, hitzegebogenes Glas

Glasdicke: 12 mm  
Abmessung: 45 x 31.5 x H66 cm  
(LängexBreitexHöhe)  
Nettogewicht: 14 kg

ET065G: Glas grau getönt  
ET065F: Glas klar  
ET065R: Glas ultraklar

# AKANTE®

LOOP®



# LOOP<sup>®</sup>

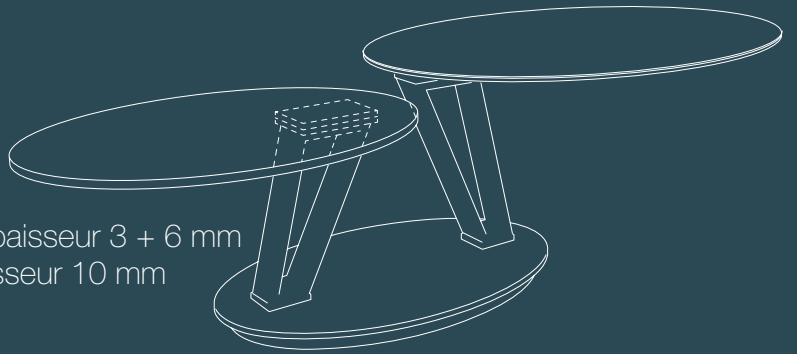

## TABLE BASSE CT138 / CT338

Plateau supérieur : Céramique sur verre épaisseur 3 + 6 mm  
Plateau inférieur : Verre clair trempé épaisseur 10 mm  
Pieds et base : Acier laqué noir mat

Dimension fermée : 95 x 60 x h43 cm  
Dimension ouverte : 150 x 60 x h43 cm  
Poids Net : 55 kg

CT338 : Base équipée de roulettes

CT138/338 TI / SD / AR / SI / MA / CC :

Plateau en céramique titane / acier / argile / silver / marbre mat / chêne clair

© Modèle déposé (Réf. INPI : 20190743)

## COFFEE TABLE CT138 / CT338

Top plate : Ceramic over glass thickness 3 + 6 mm  
Lower plate : Clear tempered glass thickness 10 mm  
Base : Matt black painted steel

Dimension closed : 95 x 60 x H43 cm  
Dimension open : 150 x 60 x H43 cm  
Net Weight : 55 kgs

CT338 : Base with wheels

CT138/338 TI / SD / AR / SI / MA / CC :

Tops in ceramic titanium / steel / argile / silver / matt marble / clear oak

© Registered design (INPI : 20190743)

## COUCHTISCH CT138 / CT338

Obere Platte: Keramik auf Glas Dicke 3 + 6 mm  
Untere Platte: Temperglas Dicke 10 mm  
Bodenplatte und Tischbeine: Edelstahl schwarz matt lackiert

Abmessung geschlossen: 95 x 60 x H43 cm  
Abmessung geöffnet: 150 x 60 x H43 cm  
Nettogewicht: 55 kg

CT338: Gestell auf Rollen

CT138/338 TI / SD / AR / SI / MA / CC:

Obere Platte aus Keramik Titan / rostbraun / zementgrau / silber / Marmoroptik matt / eiche hell

© Registriertes Modell (INPI : 20190743)

# AKANTE®

LUCIA®



CT395AR



CT396MA



CT395SD



CT395C



CT396SD



CT395TI



# LUCIA<sup>®</sup>

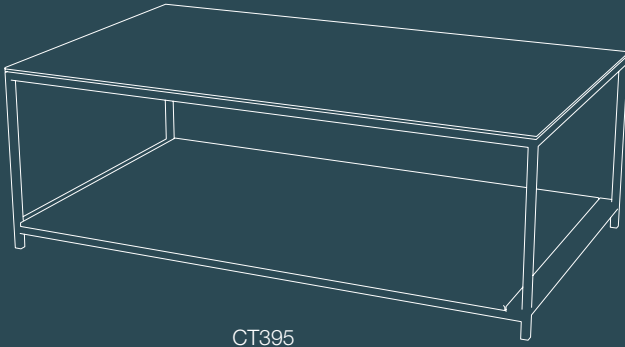

CT395

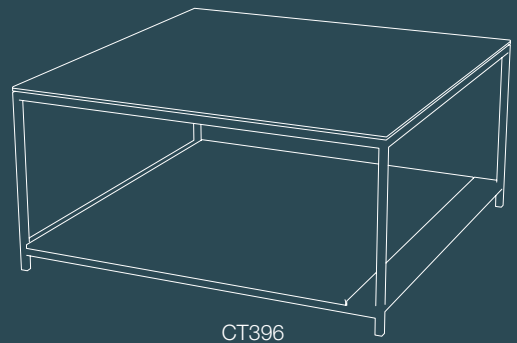

CT396

## TABLE BASSE

Plateau supérieur :

Céramique de 3 mm collée sur un verre de 6 mm d'épaisseur, couleurs : Argile (AR), Marbre Mat (MA), Acier (SD), Silver (SI), Titane (TI)

Verre trempé de 10 mm, couleur : Clair (C)

Plateau inférieur : Verre trempé de 10 mm, couleur : Clair (C)

Piètement : Acier laqué noir mat

CT395 : Dimensions : 120 x 70 x h40 cm  
Poids Net : 48 kg

CT396 : Dimensions : 85 x 85 x h40 cm  
Poids Net : 41 kg

© Modèle déposé à l'INPI

## COFFEE TABLE

Top plate :

Ceramic over glass thickness 3 + 6 mm, colours : Argile (AR), Matt marble (MA), Steel dark (SD), Silver (SI), Titanium (TI)

10 mm tempered glass, colour : Clear glass (C)

Lower plate : 10 mm tempered glass, colour : Clear glass (C)

Legs : Black lacquered steel

CT395 : Dimensions : 120 x 70 x H40 cm  
Net Weight : 48 kgs

CT396 : Dimensions : 85 x 85 x H40 cm  
Net Weight : 41 kgs

© Registered design INPI

## COUCHTISCH

Tischplatte:

Keramik auf Glas Stärke 3 + 6 mm, farben: zementgrau (AR), Marmoroptik matt (MA), rostbraun (SD), silver (SI), Titan (TI)

10 mm starkem Temperglas, farbe: Glas Klar (C)

Untere Platte: 10 mm starkem Temperglas, farbe: Glas Klar (C)

Gestell: Stahl schwarz lackiert

CT395: Abmessung: 120 x 70 x H40 cm  
Nettogewicht: 48 kg

CT396: Abmessung: 85 x 85 x H40 cm  
Nettogewicht: 41 kg

© Registriertes Modell INPI

# AKANTE®

LUNA®



# LUNA<sup>®</sup>

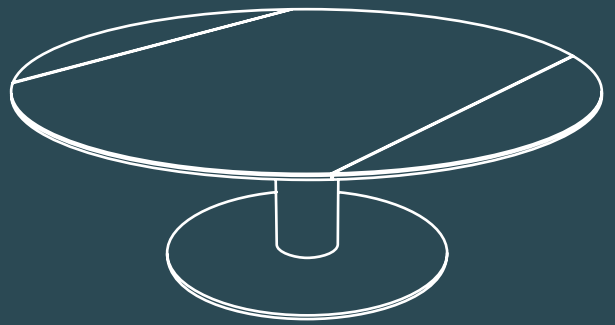

## TABLE BASSE

2 rallonges rétractables et synchronisées  
Dimensions : 110 x 110/68 x h40 cm  
Poids Net : 59 kg

Finitions plateaux :  
AR / TI : argile / titane de 3 mm collée  
sur verre de 6 mm

Finitions pieds :  
CT015 : Acier laqué gris silex mat  
CT017 : Acier laqué noir mat  
CT018 : Acier inoxydable brossé  
CT019 : Acier laqué blanc mat

© Modèle déposé (Réf. INPI : 20161761)  
Modèle breveté (Réf. INPI : FR1870192)

## COFFEE TABLE

Two synchronised pull-out extensions  
Dimensions : 110 x 110/68 x H40 cm  
Net Weight : 59 kgs

Tops finish :  
AR / TI : Argile / titanium in 3 mm ceramic glued on a 6 mm thick glass

Legs finish :  
CT015 : Flint grey lacquered steel  
CT017 : Black lacquered steel  
CT018 : Brushed stainless steel  
CT019 : White lacquered steel

© Registered design (INPI : 20161761)  
Patented model (Réf. INPI : FR1870192)

## COUCHTISCH

Mit 2 einziehbaren, synchronisierten Auszügen  
Abmessung: 110 x 110/68 x h40 cm  
Nettogewicht: 59 kg

Platten-Ausführungen:  
AR / TI: 3 mm dicke Keramik Zementgrau / Titan verklebt auf 6 mm dickem Glas

Ausführungen Gestell:  
CT015: Stahl kieselgrau matt lackiert  
CT017: Stahl schwarz matt lackiert  
CT018: Edelstahl gebürstet  
CT019: Stahl weiß matt lackiert

© Registriertes Modell (INPI 20161761)  
Patentiertes Modell (INPI FR1870192)



# AKANTE®

MALAGA®



# MALAGA<sup>®</sup>

## TABLE BASSE

CT299

Plateau supérieur : Céramique sur verre épaisseur 3 + 6 mm  
Plateau inférieur : Verre clair trempé 10 mm  
Structure et base : Acier laqué noir mat

Dimensions fermée : Ø 80 x h42 cm  
Dimensions ouverte : 135 x 80 x h42 cm  
Poids Net : 47 kg

CT299SD / AR / SI / TI / MA :

Plateau supérieur céramique acier / argile / silver / titane / marbre mat

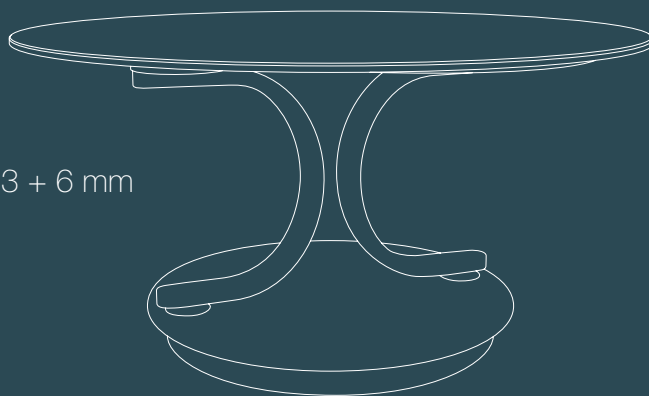

© Modèle déposé (Réf. INPI : 20190743)

## COFFEE TABLE

CT299

Top : Ceramic over glass thickness 3 + 6 mm  
Lower top : 10 mm tempered clear glass  
Base : Black lacquered steel

Dimensions closed : Ø 80 x H42 cm  
Dimensions open : 135 x 80 x H42 cm  
Net Weight : 47 kgs

CT299SD / AR / SI / TI / MA :

Tops in ceramic steel / argile / silver / titanium / matt marble

© Registered design (INPI : 20190743)

## COUCHTISCH

CT299

Obereplatte: Keramik auf Glas, Dicke 3 + 6 mm  
Untere platte: Getempertem Klarglas 10 mm  
Struktur und Gestell: Schwarz lackiertem Stahl

Abmessung geschlossen: Ø 80 x H42 cm  
Abmessung geöffnet: 135 x 80 x H42 cm  
Nettogewicht: 47 kg

CT299SD / AR / SI / TI / MA :

Oberplatte in Keramik rostbraun / zementgrau / silber / Titan / Marmoroptik

© Registriertes Modell (INPI 20190743)

# AKANTE®

MARBELLA®

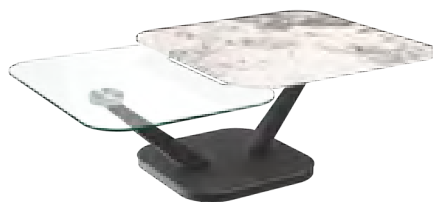

# MARBELLA<sup>®</sup>

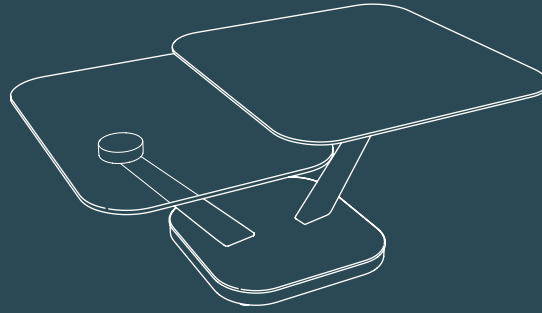

## TABLE BASSE CT268

Plateau supérieur à mécanisme synchronisé en céramique de 3 mm collé sur un verre de 6 mm ou en céramique pleine masse de 11 mm  
Plateau inférieur en verre trempé de 10 mm  
Piétement : Acier laqué noir mat

Dimensions fermée : 80 x 80 x h40 cm  
Dimensions ouverte : 127 x 80 x h40 cm  
Poids Net : 56 kg

CT268SI / AR / MA / MM / MC / SD / TI / CC :

Plateau céramique silver / argile / marbre mat / marbre Marquina / marbre Calcutta / acier / titane / chêne clair

© Modèle déposé (Réf. INPI : 20231433)

## COFFEE TABLE CT268

Main plate with synchronized system in ceramic over glass thickness 3 + 6 mm or full body ceramic thickness 11 mm  
Tempered glass second plate 10 mm  
Legs : Black lacquered steel

Dimensions closed : 80 x 80 x h40 cm  
Dimensions open : 127 x 80 x h40 cm  
Net Weight : 56 kgs

CT268SI / AR / MA / MM / MC / SD / TI / CC :

Ceramic plate silver / argile / marble matt / Marquina marble / Calcutta marble / steel dark / titanium / clear oak

© Registered design (INPI : 20231433)

## COUCHTISCH CT268

Obere Platte aus 3 mm Keramik verklebt auf 6 mm starkem Glas oder 11 mm dicke Vollkeramik mit synchronisiertem Mechanismus  
Untere Platte aus 10 mm starkem Temperglas  
Gestell aus schwarz matt lackiertem Stahl

Abmessung geschlossen: 80 x 80 x H40 cm  
Abmessung geöffnet: 127 x 80 x H40 cm  
Nettogewicht: 56 kg

CT268SI / AR / MA / MM / MC / SD / TI / CC:

Ausführungen der Keramikplatte: silver / zementgrau / Marmoroptik matt / Marmoroptik Marquina / Marmoroptik Calcutta / rostbraun / Titan / eiche hell

© Registriertes Modell (INPI : 20231433)

# AKANTE®

MEMPHIS®

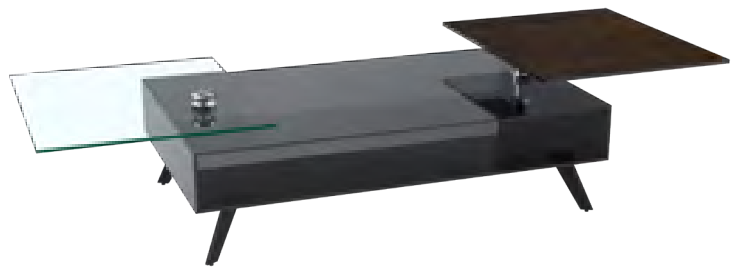
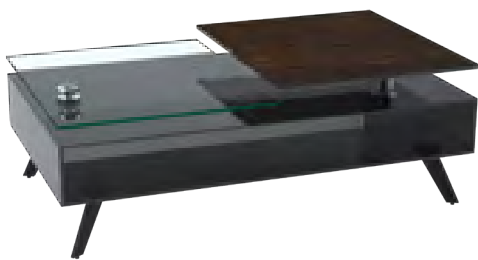

# MEMPHIS<sup>®</sup>

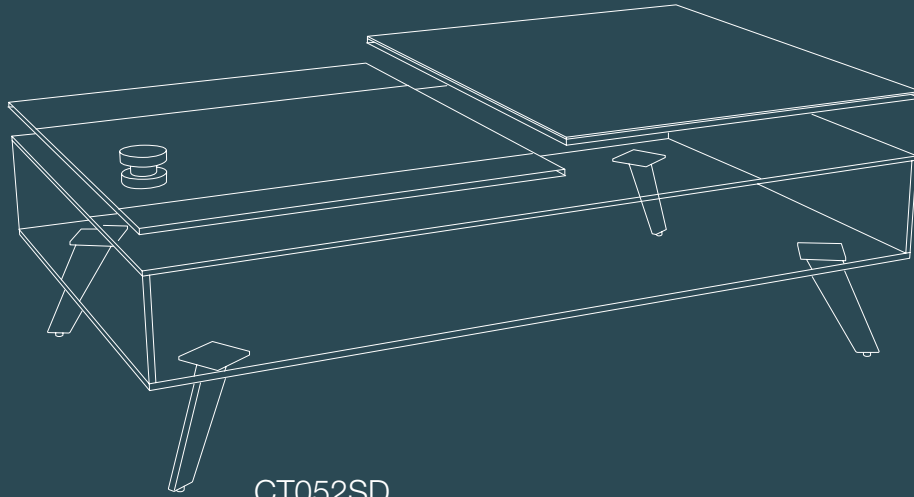

 TABLE BASSE

CT052SD

2 plateaux pivotants :  
Plateau supérieur en céramique acier de 3 mm collé sur un verre de 6 mm  
Plateau inférieur en verre clair 10 mm

Caisson en verre gris fumé de 10 mm  
Piètement en acier laqué noir mat (équipé de patins réglables)

Dimensions : 110/180 x 65 x h40 cm  
Poids Net : 55 kg

© Modèle déposé (Réf. INPI : 20173908)

 COFFEE TABLE

CT052SD

2 pivoting tops :  
Top in 3 mm steel dark ceramic glued on a 6 mm thick glass  
Lower top in 10 mm clear glass

10 mm smoked grey glass body  
Legs in black matt lacquered steel (with built-in levellers)

Dimensions : 110/180 x 65 x H40 cm  
Net Weight : 55 kgs

© Registered design (INPI : 20173908)

 COUCHTISCH

CT052SD

2 schwenkbare Tischplatten:  
Oberplatte bestehend aus 3 mm Keramikplatte in Rostbraun auf 6 mm starkem Glas  
Untere Platte aus 10 mm Klarglas

Korpus aus grau getöntem 10 mm Glas  
Füße aus schwarz lackiertem Stahl (mit plastikkappe)

Abmessung: 110/180 x 65 x H40 cm  
Nettogewicht: 55 kg

© Registriertes Modell (INPI 20173908)

# AKANTE®

MILANO®

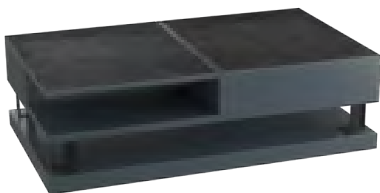
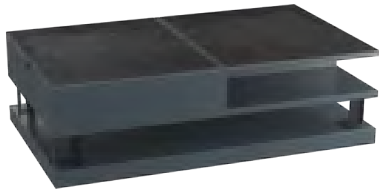

# MILANO<sup>®</sup>

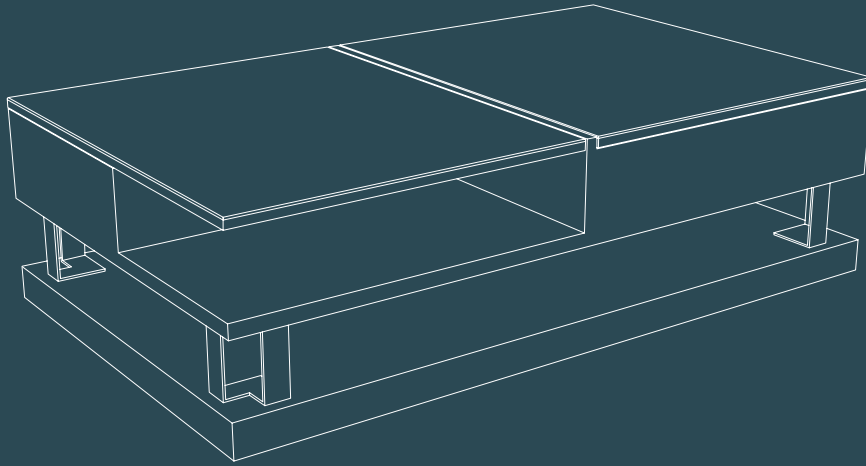

## TABLE BASSE

Structure en MDF laqué gris anthracite  
2 tablettes relevables en MDF recouvertes de céramique titane  
Ouverture bi-directionnelle - Table sur roulettes  
Piétement : Acier laqué noir

Dimensions : 120 x 70 x h38 cm  
Hauteur tablette déployée : 60 cm - Poids Net : 63 kg

CT262TI : Tablette de gauche déployée vers l'utilisateur, la tablette latérale s'ouvre vers la droite  
CT263TI : Tablette de droite déployée vers l'utilisateur, la tablette latérale s'ouvre vers la gauche

© Modèle déposé (Réf. INPI : 20200478)

## COFFEE TABLE

Structure in charcoal lacquered MDF  
2 MDF adjustable trays covered with titanium ceramic  
Bi-directional opening - With wheels  
Legs : Lacquered steel

Dimensions : 120 x 70 x H38 cm  
Tray height when lifted up : 60 cm - Net Weight : 63 kgs

CT262TI : Left tray opened towards user, side tray opening on the right  
CT263TI : Right tray opened towards user, side tray opening on the left

© Registered design (INPI : 20200478)

## COUCHTISCH

Korpus MDF Anthrazitgrau lackiert  
2 aufklappbare MDF-Platten mit Keramik Titan  
Bi-direktionelle Öffnung - Tisch auf Rollen  
FüÙe: Edelstahl schwarz lackiert

Abmessung: 120 x 70 x H38 cm  
Höhe bei aufgeklappten Platten: 60 cm - Nettogewicht: 63 kg

CT262TI: Linke Tischplatte zum Verbraucher, die seitliche Tischplatte öffnet nach rechts  
CT263TI: Rechte Tischplatte zum Verbraucher, die seitliche Tischplatte öffnet nach links

© Registriertes Modell (INPI : 20200478)



# AKANTE®

MONOLITH®



# MONOLITH®

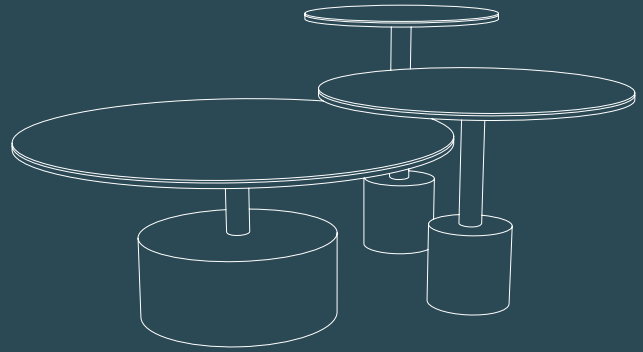

 Gamme MONOLITH

CT700

Disponible en table basse et bout de canapé  
Gamme 100 % personnalisable avec un vaste choix  
de finitions et de dimensions

Céramiques AR / MA / SD / SI / TI / CC :

Plateau céramique argile / marbre mat / acier / silver / titane / chêne clair sur verre épaisseur 3 + 6 mm

Piètement : Acier laqué noir mat

## TABLE BASSE

Ø 75 x h33 cm  
h40 cm

## BOUT DE CANAPÉ

Ø 40 ou 55 cm x h33 cm  
h40 cm  
h50 cm

© Modèle déposé (Réf. INPI : 20222320)

 The MONOLITH Collection

CT700

Available in coffee table and end table  
Diverse selection and 100% customizable

Ceramics AR / MA / SD / SI / TI / CC :

Plates in ceramic argile / matt marble / steel / silver / titanium / clear over glass thickness 3 + 6 mm

Legs and base : Black lacquered steel

## COFFEE TABLE

Ø 75 x H33 cm  
H40 cm

## END TABLE

Ø 40 or 55 cm x H33 cm  
H40 cm  
H50 cm

© Registered design (INPI : 20222320)

 Tischserie MONOLITH

CT700

Erhältlich als Couchtisch, geeignet auch als Beistelltisch  
Breites Spektrum und für jeden Gebrauch anpassbar

Erhältlich in den Ausführungen AR / MA / SD / SI / TI / CC:

3 mm Keramikplatte in zementgrau / Marmoroptik matt / rostbraun / silver / Titan / eiche hell auf 6 mm  
starkem Glas

Gestell: Stahl Schwarz lackiert

## COUCHTISCH

Ø 75 x H33 cm  
H40 cm

## BEISTELLTISCH

Ø 40 oder 55 cm x H33 cm  
H40 cm  
H50 cm

© Registriertes Modell (INPI : 20222320)

# AKANTE®

MONZA®



# MONZA<sup>®</sup>

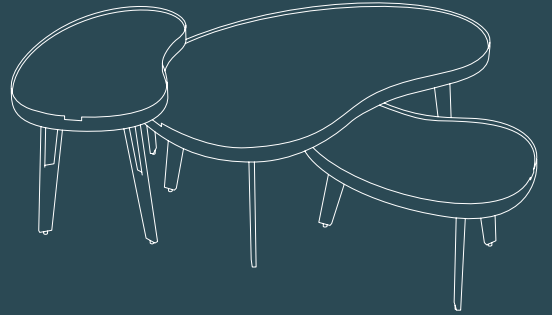

Plateau supérieur :

Céramique pleine masse de 11 mm, couleurs : Marquina (**MM**), Calcatta (**MC**), Onyx bleu (**MO**), Emperador (**ME**)  
Ceinture acier effet bronze ou acier laqué noir de 4 cm de hauteur

Piètement : Acier laqué noir mat (équipé de patins réglables)

## TABLE BASSE

Pieds pleins : CT318 / CT319 / CT518 / CT519

Pieds ajourés : CT428 / CT432 / CT634 / CT635

Dimensions : 100 x 60 x h33 cm  
h38 cm  
h43 cm  
h50 cm

Poids Net : 24 kg

## COIN CANAPÉ

Pieds pleins : ET318 / ET319 / ET518 / ET519

Pieds ajourés : ET428 / ET432 / ET634 / ET636

Dimensions : 60 x 36 x h33 cm  
h38 cm  
h43 cm  
h50 cm

Poids Net : 13 kg

© Modèle déposé (Réf. INPI : 20222320)



Top plate :

Full body ceramic thickness 11 mm, colours : Marquina (**MM**), Calcatta (**MC**), Onyx blue (**MO**), Emperador (**ME**)  
Steel frame with bronze effect or black lacquered steel, Height 4 cm

Legs : Black lacquered steel (with built-in levellers)

## COFFEE TABLE

Solid legs : CT318 / CT319 / CT518 / CT519

Open-style legs : CT428 / CT432 / CT634 / CT635

Dimensions : 100 x 60 x H33 cm  
H38 cm  
H43 cm  
H50 cm

Net weight : 24 kgs

## END TABLE

Solid legs : ET318 / ET319 / ET518 / ET519

Open-style legs : ET428 / ET432 / ET634 / ET636

Dimensions : 60 x 36 x H33 cm  
H38 cm  
H43 cm  
H50 cm

Net weight : 13 kgs

© Registered design (INPI : 20222320)



Tischplatte:

11 mm dicke Vollkeramik, farben: Marquina (**MM**), Calcatta (**MC**), Onyx blau (**MO**), Emperador (**ME**)  
Messingfarbener Stahlgürtel oder schwarz lackierter Stahl mit 4 cm Höhe

Gestell : Stahl schwarz matt lackiert (mit plastikcappe)

## COUCHTISCH

Tischbeine ganz: CT318 / CT319 / CT518 / CT519

Oder durchbrochen: CT428 / CT432 / CT634 / CT635

Abmessung: 100 x 60 x H33 cm  
H38 cm  
H43 cm  
H50 cm

Nettogewicht: 24 kg

## BEISTELLTISCH

Tischbeine ganz: ET318 / ET319 / ET518 / ET519

Oder durchbrochen: ET428 / ET432 / ET634 / ET636

Abmessung: 60 x 36 x H33 cm  
H38 cm  
H43 cm  
H50 cm

Nettogewicht: 13 kg

© Registriertes Modell (INPI : 20222320)

# AKANTE®

MOOREA®



# MOOREA<sup>®</sup>

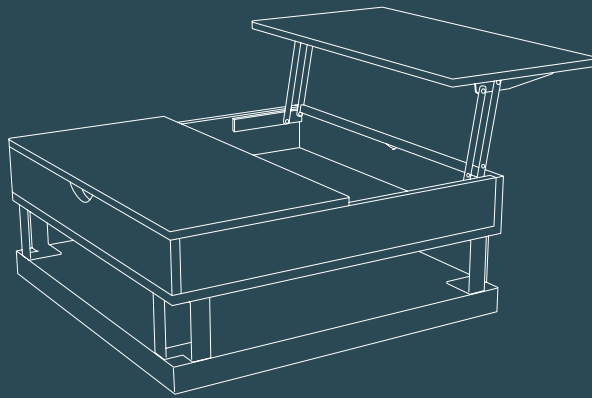

## TABLE BASSE

CT275

Structure et base en MDF plaqué chêne  
Tablettes relevables en céramique acier sur MDF noir  
Base sur roulettes équipé de freins

Dimension fermée : 80 x 80 x h35 cm  
Dimension ouverte : 80 x 130 x h56 cm  
Poids Net : 46 kg

© Modèle déposé (Réf. INPI : 20215513)

## COFFEE TABLE

CT275

Structure and base in MDF oak veneer  
Lifting shelves in steel ceramic over black MDF  
Base on wheels with brakes

Dimension closed : 80 x 80 x H35 cm  
Dimension open : 80 x 130 x H56 cm  
Net Weight : 46 kgs

© Registered design (INPI : 20215513)

## COUCHTISCH

CT275

Korpus und Bodenplatte aus MDF mit Eichenfurnier  
Mit rostbraun anhebbaren Keramikplatten auf schwarzem MDF  
Auf bremsbaren Laufrollen

Abmessung geschlossen: 80 x 80 x H35 cm  
Abmessung geöffnet: 80 x 130 x H56 cm  
Nettogewicht: 46 kg

© Registriertes Modell (INPI : 20215513)

# AKANTE®

OCTANE - OVALIA®



CT336SI



CT136TI



CT336MA



CT134CH



CT334SD



CT134AR



# OCTANE - OVALIA<sup>®</sup>

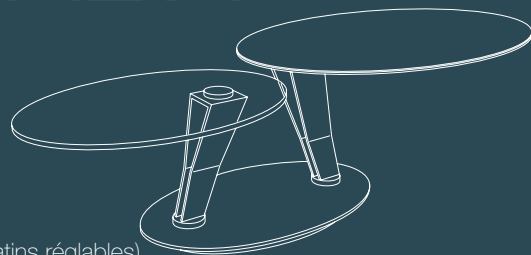

## TABLE BASSE CT136 / CT134 / CT334 / CT344

Plateau supérieur : Céramique collée sur verre épaisseur 3 + 6 mm  
Plateau inférieur : Verre clair trempé épaisseur 10 mm ou céramique  
Piétement : CT136 / CT336 : Acier laqué taupe mat (équipé de patins réglables)  
CT134 / CT334 : Acier laqué noir mat (équipé de patins réglables)  
CT344 / CT354 : Acier laqué noir mat - Base équipée de roulettes

Dimension fermée : 95 x 60 x h43 cm  
Dimension ouverte : 150 x 60 x h43 cm  
Poids Net : 55 kg

CT136 / 134 / 344CH : Plateau supérieur en MDF plaqué chêne

Céramiques MA / SD / AR / TI / SI / CC :

CT136 / 134 / 344 : Plateau supérieur en céramique marbre mat / acier / argile / titane / silver / chêne clair  
CT336 / 334 / 354 : Double Plateau en céramique marbre mat / acier / argile / titane / silver / chêne clair

© Modèle déposé (Réf. INPI : 20190743)

## COFFEE TABLE CT136 / CT134 / CT334 / CT344

Top plate : Ceramic over glass thickness 3 + 6 mm  
Lower plate : Clear tempered glass thickness 10 mm or ceramic  
Legs : CT136 / CT336: Matt taupe painted steel (with built-in levellers)  
CT134 / CT334: Matt black painted steel (with built-in levellers)  
CT344 / CT354: Matt black painted steel - Base with wheels

Dimension closed : 95 x 60 x H43 cm  
Dimension open : 150 x 60 x H43 cm  
Net Weight : 55 kgs

CT136 / 134 / 344CH : Top plate in in oak veneered MDF

Ceramics MA / SD / AR / TI / SI / CC :

CT136 / 134 / 344 : Top Plate in ceramic matt marble / steel dark / argile / titanium / silver / clear oak  
CT336 / 334 / 354 : Double Plate in ceramic matt marble / steel dark / argile / titanium / silver / clear oak

© Registered design (INPI : 20190743)

## COUCHTISCH CT136 / CT134 / CT334 / CT344

Obere Platte: Aus Keramik auf Glas Stärke 3 + 6 mm  
Untere Platte: Klares Temperglas Stärke 10 mm oder Keramik  
Gestell und Bodenplatte: CT136 / CT336: Stahl taupe matt lackiert (mit plastikkappe)  
CT134 / CT334: Stahl schwarz matt lackiert (mit plastikkappe)  
CT344 / CT354: Stahl schwarz matt lackiert - Gestell auf Rollen

Abmessung geschlossen: 95 x 60 x H43 cm  
Abmessung geöffnet: 150 x 60 x H43 cm  
Nettogewicht: 55 kg

CT136 / 134 / 344CH: Obere Platte aus MDF mit Eichenfurnier

Keramiken MA / SD / AR / TI / SI / CC:

CT136 / 134 / 344: Obere Platte aus Keramik Marmoroptik matt / rostbraun / zementgrau / Titan / silver / eiche hell  
CT336 / 334 / 354: Doppelplatte aus Keramik Marmoroptik matt / rostbraun / zementgrau / Titan / silver / eiche hell

© Registriertes Modell (INPI : 20190743)



# AKANTE®

OGIVE®  
AVEC ET SANS TABLETTES



CT502SD



CT502AR



CT303MA



CT304TI



CT304SD



# OGIVE<sup>®</sup>

AVEC ET SANS TABLETTES

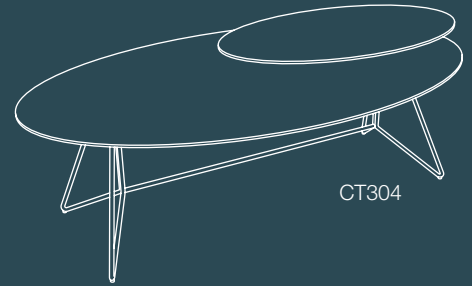
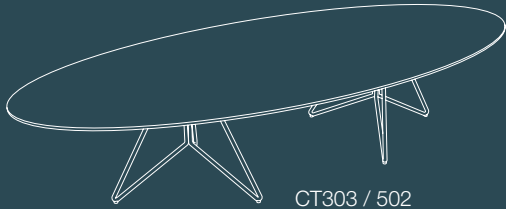

## TABLE BASSE CT303 / CT502 / CT304

Plateaux et tablette rotative à 360° : céramique sur verre épaisseur 3+6 mm  
Pieds : Acier peinture epoxy noir mat

CT303 : Dimensions : 145 x 60 x h30 cm - Poids Net : 19 kg  
CT502 : Dimensions : 145 x 60 x h38 cm - Poids Net : 20 kg  
CT304 : Dimensions : 120 x 70 x h38/43 cm - Poids Net : 28 kg

CT303 / 502 AR / TI / MA / SD :

Plateau en céramique titane / argile / marbre mat / acier

CT304SD : Plateau principal en céramique acier et sa tablette en céramique argile

CT304TI : Plateau principal en céramique titane et sa tablette en céramique marbre mat

© Modèles déposés (Réf. INPI : 20173908 - 20190743)

## COFFEE TABLE CT303 / CT502 / CT304

Top and 360° rotation tray in ceramic over glass thickness 3+6 mm  
Black epoxy painted steel legs

CT303 : Dimensions : 145 x 60 x H30 cm - Net Weight : 19 kgs  
CT502 : Dimensions : 145 x 60 x H38 cm - Net Weight : 20 kgs  
CT304 : Dimensions : 120 x 70 x H38/43 cm - Net Weight : 28 kgs

CT303 / 502 AR / TI / MA / SD :

Top in ceramic argile / titanium / matt marble / steel

CT304SD : Main plate in steel ceramic with tablette in argile ceramic

CT304TI : Main plate in titanium ceramic with tablette in matt marble ceramic

© Registered designs (INPI : 20173908 - 20190743)

## COUCHTISCH CT303 / CT502 / CT304

3 mm Keramikplatten auf 6 mm starkem Glas, obere Platte um 360° drehbar  
Tischfüße Edelstahl schwarz lackiert

CT303: Abmessung: 145 x 60 x H30 cm - Nettogewicht: 19 kg  
CT502: Abmessung: 145 x 60 x H38 cm - Nettogewicht: 20 kg  
CT304: Abmessung: 120 x 70 x H38/43 cm - Nettogewicht: 28 kg

CT303 / 502 AR / TI / MA / SD:

Keramikplatte zementgrau / Titan / Marmoroptik matt / rostbraun

CT304SD: Hautplatte aus Keramik rostbraun und eine Drehplatte Keramik zementgrau

CT304TI: Hautplatte aus Keramik Titan und eine Drehplatte Keramik Marmoroptik matt

© Registrierte Modelle (INPI 20173908 - 20190743)

# AKANTE®

OLIVEA - TINA ©



# TINA

 **BOUT DE CANAPE** ET067  
Verre courbé à chaud haute résistance épaisseur : 12 mm  
Dimensions : 43 x 30 x 70 cm  
Poids Net : 16 kg

 **END TABLE** ET067  
High resistance hot bent glass Thickness : 12 mm  
Dimensions : 43 x 30 x 70 cm  
Net Weight : 16 kgs

 **BEISTELLTISCH** ET067  
12 mm starkes hitzegebogenes Glas  
Abmessung: 43 x 30 x 70 cm  
Nettogewicht: 16 kg



# OLIVEA

 **TABLES GIGOGNES** NT004  
Verre courbé à chaud haute résistance épaisseur 10 mm  
Dimensions : 42 x 42 x 42 cm / 38 x 38 x 38 cm / 34 x 34 x 34 cm  
Poids total : 37 kg

NT004 : Verre clair  
NT004R : Verre cristallin  
NT004G : Verre gris fumé

 **NEST OF TABLES** NT005 (Tempered)  
High resistance clear hot bent glass thickness 10 mm  
Dimensions : 42 x 42 x 42 cm / 38 x 38 x 38 cm / 34 x 34 x 34 cm  
Total Weight : 37 kgs

NT005 : Clear glass  
NT005R : Crystal glass  
NT005G : Grey tinted glass

 **SATZTISCHE** NT004  
10 mm starkes hitzegebogenes Glas  
Abmessung: 42 x 42 x 42 cm / 38 x 38 x 38 cm / 34 x 34 x 34 cm  
Gesamtgewicht: 37 kg

NT004: Klarglas  
NT004R: ultraklares Glas  
NT004G: grau getöntes Glas

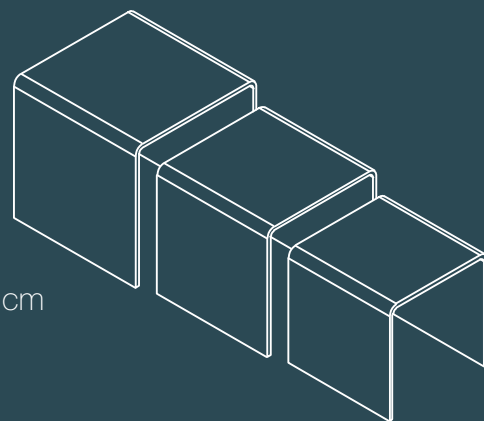

# AKANTE®

OMEGA - VEGA®



CT124MB



CT124MA



CT124SD



CT123C



CT123AR



CT123TI



# OMEGA - VEGA®

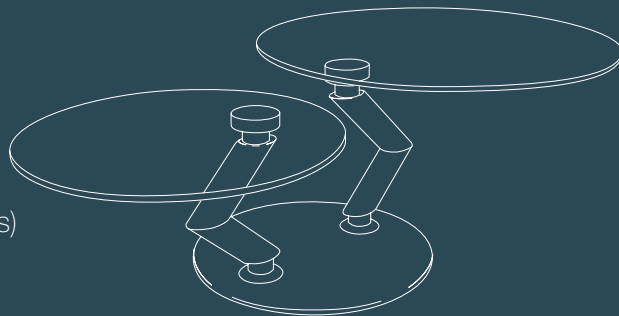

## TABLE BASSE

CT124 / CT123

Plateau inférieur : Verre clair trempé 10 mm  
CT124 : Base : Acier chromé (équipée de patins réglables)  
CT123 : Base : Acier laqué noir mat (équipée de patins réglables)

Dimension fermée : 105 x 80 x 40 cm  
Dimension ouverte : 139 x 80 x 40 cm  
Poids Net : 45 kg

CT123/124C : Plateau supérieur en verre clair trempé 10 mm  
CT123/124MB : Plateau supérieur en verre feuilleté avec maille d'acier épaisseur 10 mm

Céramiques AR / MA / SD / TI / SI :  
Plateau supérieur en céramique argile / marbre mat / acier / titane / silver sur verre épaisseur 3+6 mm

© Modèle déposé (Réf. INPI : 20173908)

## COFFEE TABLE

CT124 / CT123

Lower Top : Clear 10 mm tempered glass  
CT124 : Base : Chrome steel (with built-in levellers)  
CT123 : Base : Black lacquered steel (with built-in levellers)

Dimension closed : 105 x 80 x 40 cm  
Dimension open : 139 x 80 x 40 cm  
Net Weight : 45 kgs

CT123/124C : Upper top in 10 mm clear tempered glass  
CT123/124MB : Upper top in laminated glass with steel mesh thickness 10 mm

Ceramics AR / MA / SD / TI / SI :  
Upper top in ceramic argile / matt marble / steel / titanium / silver over glass thickness 3+6 mm

© Registered design (INPI : 20173908)

## COUCHTISCH

CT124 / CT123

Untere Platte: 10 mm Temperklarglas  
CT124: Gestell: Stahl verchromt (mit plastikkappe)  
CT123: Gestell: Stahl pulverbeschichtet schwarz (mit plastikkappe)

Abmessung geschlossen: 105 x 80 x 40 cm  
Abmessung geöffnet: 139 x 80 x 40 cm  
Nettogewicht: 45 kg

CT123/124C: Oberplatte aus 10 mm starkem Temperglas klar  
CT123/124MB: Oberplatte aus 10 mm starkem Verbundglas mit eingebettetem Stahlgeflecht

Keramiken AR / MA / SD / TI / SI:  
Oberplatte aus Keramik zementgrau / Marmoroptik matt / rostbraun / Titan / silver auf Glas, Stärke 3+6 mm

© Registriertes Modell (INPI 20173908)

# AKANTE®

OPÉRA®  
SIMPLE ET DOUBLE CÉRAMIQUE



CT097SD



CT097AR

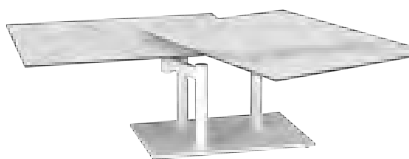

CT188MA



CT288AR



CT087TI



# OPÉRA<sup>®</sup>

## SIMPLE ET DOUBLE CÉRAMIQUE

### TABLE BASSE

Dimension fermée : 90 x 60 x h42 cm  
Dimension ouverte : 150 x 60 x h42 cm  
Poids Net : 45 kg

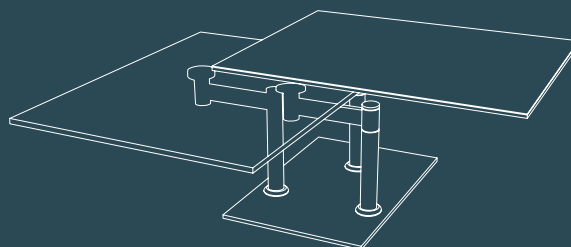

#### CT097AR / MA / SD / SI / TI / CC :

Plateau supérieur en céramique argile / marbre mat / acier / silver / titane / chêne clair ép. 3 mm sur verre 6 mm  
Plateau inférieur en verre clair trempé, épaisseur 10 mm  
Pieds et base en acier laqué noir mat (équipés de patins réglables)

CT087 / CT188 / CT288 : Plateaux en céramique de 3 mm collée sur un verre de 6 mm d'épaisseur  
Pieds et bases en acier laqué (équipés de patins réglables)

CT087 SD / SI / TI : Pieds et base en acier laqué noir mat, plateaux en céramique acier / silver / titane  
CT288AR : Pieds et base en acier laqué taupe, plateaux en céramique argile  
CT188MA : Pieds et base en acier laqué blanc mat, plateaux en céramique marbre

### COFFEE TABLE

© Modèle déposé (Réf. INPI : 20173908)

Dimension closed : 90 x 60 x H42 cm  
Dimension open : 150 x 60 x H42 cm  
Net Weight : 45 kgs

#### CT097AR / MA / SD / SI / TI / CC :

Top in 3 mm argile / matt marble / steel dark / silver / titanium / clear oak ceramic over 6 mm glass  
Lower plate in clear tempered glass, thickness 10 mm  
Structure in mat black painting steel (with built-in levellers)

CT087 / 188 / 288 : Plates in ceramic over glass, thickness 3+6 mm  
Structure in painting steel (with built-in levellers)

CT087SD / SI / TI : Base and legs in mat black painting steel, plates in steel dark / silver / titanium ceramic  
CT228AR : Base and legs in taupe painting steel, plates in argile ceramic  
CT188MA : Base and legs in white painting steel, plates in marble ceramic

### COUCHTISCH

© Registered design (INPI : 20173908)

Abmessung geschlossen: 90 x 60 x H42 cm  
Abmessung geöffnet: 150 x 60 x H42 cm  
Nettogewicht: 45 kg

#### CT097 AR / MA / SD / SI / TI:

Oberplatte aus Keramik zementgrau / Marmoroptik Matt / rostbraun / silber / Titan / eiche hell auf Glas, Stärke 3+6 mm  
Untere Platte aus getempertem Klarglas, Dicke 10 mm  
Gestell und Füße aus Stahl, schwarz lackiert (mit plastikkappe)

CT087 / CT188 / CT288: Keramikplatten auf Glas, Stärke 3+6 mm  
Gestell und Füße aus Stahl (mit plastikkappe)

CT087SD / SI / TI: Bodenplatte und Tischsäulen aus schwarz matt lackiertem Stahl.  
Keramikplatten in rostbraun / Silver / Titan  
CT228AR: Bodenplatte und Tischsäulen aus lackiertem Stahl in Farbe taupe.  
Keramikplatten in zementgrau  
CT188MA: Bodenplatte und Tischsäulen aus weiß lackiertem Stahl.  
Keramikplatten in Marmoroptik



# AKANTE®

OSIRIS®



# OSIRIS<sup>®</sup>

## TABLE BASSE

CT142

Dimensions fermée : 95 x 59 x h42 cm  
Dimensions ouverte : 163 x 59 x h42 cm  
Poids Net : 47 kg

Plateau inférieur en verre clair trempé 10 mm  
Structure et base en acier laqué noir mat

CT352 : Base équipée de roulettes

CT142C : Plateau supérieur en verre clair trempé 10 mm

CT142SD / AR / TI / MA / SI / CC :

Plateau supérieur céramique acier / argile / titane / marbre mat / silver / chêne clair sur verre épaisseur 3 + 6 mm

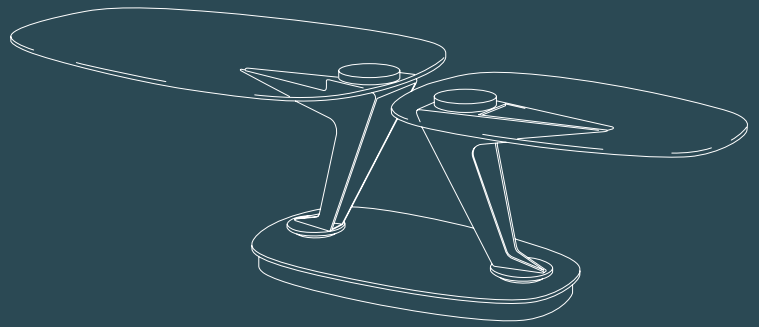

© Modèle déposé (Réf. INPI : 20200478)

## COFFEE TABLE

CT142

Dimensions closed : 95 x 59 x H42 cm  
Dimensions open : 163 x 59 x H42 cm  
Net Weight : 47 kgs

Lower top in 10 mm clear glass  
Base : black lacquered steel

CT352 : Base with wheels

CT142C : Top in 10 mm clear glass

CT142SD / AR / TI / MA / SI / CC :

Top in ceramic steel / argile / titanium / matt marble / silver / clear oak over glass 3 + 6 mm

© Registered design (INPI : 20200478)

## COUCHTISCH

CT142

Abmessung geschlossen: 95 x 59 x H42 cm  
Abmessung geöffnet: 163 x 59 x H42 cm  
Nettogewicht: 47 kg

Untere Platte aus getempertem Klarglas 10 mm  
Struktur und Gestell aus schwarz lackiertem Stahl

CT352: Gestell auf Rollen

CT142C: Oberplatte aus getempertem Klarglas 10 mm

CT142SD / AR / TI / MA / SI / CC:

Oberplatte aus Keramik in rostbraun / rementgrau / Titan / Marmoroptik / silver / eiche hell auf glas  
stärke 3 + 6 mm

© Registriertes Modell (INPI : 20200478)

# AKANTE®

OXANA

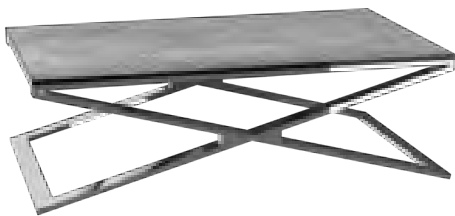

# OXANA

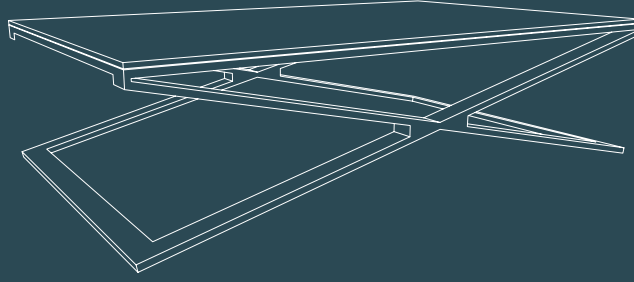

🇫🇷 Structure : Acier inoxydable poli  
Plateau : verre trempé 10 mm ou céramique de 3 mm collée sur verre de 6 mm d'épaisseur  
Vaste choix de finitions pour le plateau

## TABLE DE SALON

### CT108 :

Dimensions : 110 x 65 x h34 cm  
Poids Net : 28 kg

### CT104 :

Dimensions : 130 x 80 x h34 cm  
Poids Net : 38 kg

🇬🇧 Base : Polished stainless steel  
Top : 10 mm tempered glass or ceramic over glass 3 + 6 mm  
Large choice of finishes for top

## COFFEE TABLE

### CT108 :

Dimensions : 110 x 65 x h34 cm  
Net Weight : 28 kgs

### CT104 :

Dimensions : 130 x 80 x h34 cm  
Net Weight : 38 kgs

🇩🇪 Gestell: Edelstahl glanz poliert  
Tischplatte: Temperglas Stärke 10 mm oder Keramik auf Glas Stärke 3 + 6 mm  
Große Auswahl an Plattenausführungen

## COUCHTISCH

### CT108:

Abmessung: 110 x 65 x H34 cm  
Nettogewicht: 28 kg

### CT104:

Abmessung: 130 x 80 x H34 cm  
Nettogewicht: 38 kg

# AKANTE®

OZONE - OZONE BLACK®  
SIMPLE ET DOUBLE CÉRAMIQUE



CT546CC



CT547MC



CT546SD



CT547MM



CT546AR



CT647TI



CT646SI



CT547C



CT646MA



CT547G



# OZONE - OZONE BLACK<sup>®</sup>

SIMPLE ET DOUBLE CÉRAMIQUE

## TABLE BASSE CT546 / CT547 / CT646 / CT647

Dimension fermée : Ø 75 x h41,5 cm  
Dimension ouverte : 75 x 130 x h41,5 cm  
Poids Net : 45,5 kg

CT547 / CT647 : Structure en acier chromé (équipé de patins réglables)

CT546 / CT646 : Structure en acier laqué noir mat (équipé de patins réglables)

Plateau supérieur :

Céramique de 3 mm collée sur un verre de 6 mm d'épaisseur, couleurs : Argile (AR), Marbre Mat (MA), Acier (SD), Silver (SI), Titane (TI) Chêne Clair (CC)

Céramique pleine masse de 11 mm, couleurs : marbre Marquina (MM), marbre Calcatta (MC)

Verre trempé de 10 mm, couleur : Clair (C), Gris Fumé (G)

Plateau inférieur : Verre trempé ou céramique

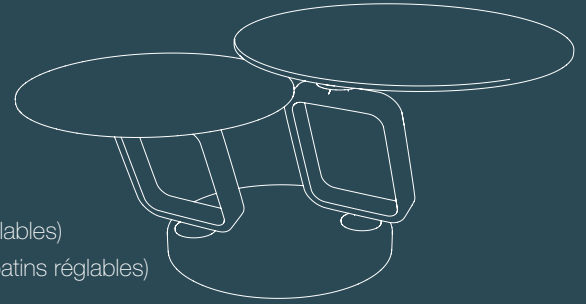

© Modèles déposés (Réf. INPI : 20231433)

## COFFEE TABLE CT546 / CT547 / CT646 / CT647

Dimension closed : Ø 75 x H41,5 cm  
Dimension open : 75 x 130 x H41,5 cm  
Net Weight : 45,5 kgs

CT547 / CT647 : Structure in chrome steel (with built-in levellers)

CT546 / CT646 : Structure in mat black painting steel (with built-in levellers)

Top plate :

Ceramic over glass thickness 3 + 6 mm, colours : Argile (AR), Matt marble (MA), Steel dark (SD), Silver (SI), Titanium (TI), Clear oak (CC)

Full body ceramic thickness 11 mm, colours : Marquina marble (MM), Calcatta marble (MC)

10 mm tempered glass, colours : Clear glass (C), Smoked grey glass (G)

Lower plate : tempered glass or ceramic

© Registered design (Réf INPI : 20231433)

## COUCHTISCH CT546 / CT547 / CT646 / CT647

Abmessung geschlossen: Ø 75 x H41,5 cm  
Abmessung geöffnet: 75 x 130 x H41,5 cm  
Nettogewicht: 45,5 kg

CT545 / CT645: Gestell aus verchromtem Stahl (mit plastikkappe)

CT546 / CT646: Gestell aus Stahl schwarz matt lackiert (mit plastikkappe)

Tischplatte:

Keramik auf Glas Stärke 3 + 6 mm, farben: zementgrau (AR), Marmoroptik matt (MA), rostbraun (SD), silver (SI), Titan (TI), eiche hell (CC)

11 mm dicke Vollkeramik, farben: Marmoroptik Marquina (MM), Marmoroptik Calcatta (MC)

10 mm starkem Temperglas, farben: Glas Klar (C), Glas grau getönt (G)

Untere Platte: Temperglas Stärke oder Keramik

© Registriertes Modell (INPI 20231433)

# AKANTE®

POLARIS®  
SIMPLE ET DOUBLE CÉRAMIQUE



CT528MC



CT528MM



CT528CC



CT528CC



CT528G



CT628AR



CT628TI



CT628SI



CT628MA



CT628SD



# POLARIS<sup>®</sup>

## SIMPLE ET DOUBLE CÉRAMIQUE

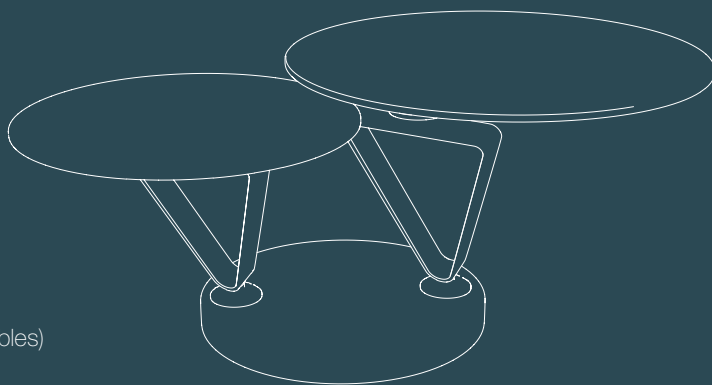

### TABLE BASSE CT528 / CT628

Dimension fermée : Ø 75 x h41,5 cm  
Dimension ouverte : 130 x 75 x h41,5 cm  
Poids Net : 45,5 kg

Structure : acier laqué noir mat (équipé de patins réglables)

Plateau supérieur :

Céramique de 3 mm collée sur un verre de 6 mm d'épaisseur, couleurs : Argile (AR), Marbre Mat (MA), Acier (SD), Silver (SI), Titane (TI) Chêne Clair (CC)

Céramique pleine masse de 11 mm, couleurs : Marquina (MM), Calcatta (MC)

Verre trempé de 10 mm, couleur : Clair (C), Gris Fumé (G)

Plateau inférieur : Verre trempé ou céramique

© Modèle déposé (Réf. INPI : 20231433)

### COFFEE TABLE CT528 / CT628

Dimension closed : Ø 75 x H41,5 cm  
Dimension open : 130 x 75 x H41,5 cm  
Net Weight : 45,5 kgs

Structure : mat black painting steel (with built-in levellers)

Top plate :

Ceramic over glass thickness 3 + 6 mm, colours : Argile (AR), Matt marble (MA), Steel dark (SD), Silver (SI), Titanium (TI), Clear oak (CC)

Full body ceramic thickness 11 mm, colours : Marquina (MM), Calcatta (MC)

10 mm tempered glass, colours : Clear glass (C), Smoked grey glass (G)

Lower plate : tempered glass or ceramic

© Registered design (Réf INPI : 20231433)

### COUCHTISCH CT528 / CT628

Abmessung geschlossen: Ø 75 x H41,5 cm  
Abmessung geöffnet: 130 x 75 x H41,5 cm  
Nettogewicht: 45,5 kg

Gestell: Stahl schwarz matt lackiert (mit plastikkappe)

Tischplatte:

Keramik auf Glas Stärke 3 + 6 mm, farben: zementgrau (AR), Marmoroptik matt (MA), rostbraun (SD), silver (SI), Titan (TI), eiche hell (CC)

11 mm dicke Vollkeramik, farben: Marquina (MM), Calcatta (MC)

10 mm starkem Temperglas, farben: Glas Klar (C), Glas grau getönt (G)

Untere Platte: Temperglas Stärke oder Keramik

© Registriertes Modell (INPI 20231433)



# AKANTE®

PORTO®  
SIMPLE ET DOUBLE CÉRAMIQUE



CT525AR



CT525MA



CT525C



CT525G



CT625SI



CT625CC



CT625SD





CT625MA

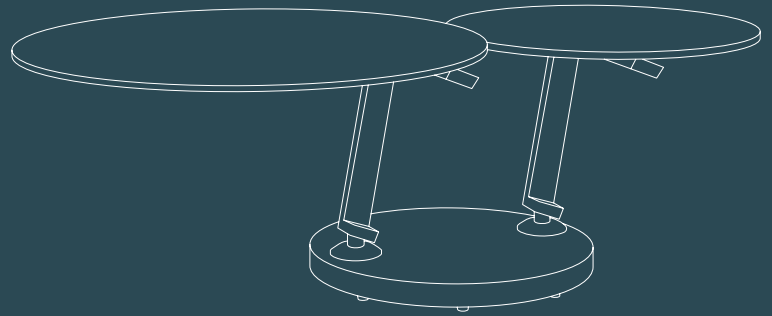

# PORTO<sup>®</sup>

SIMPLE ET DOUBLE CÉRAMIQUE



 **TABLE BASSE** CT525 / CT625

Plateau supérieur :

Céramique de 3 mm collée sur un verre de 6 mm d'épaisseur, couleurs : Argile (AR), Marbre Mat (MA), Acier (SD), Silver (SI), Titane (TI), Chêne clair (CC)

Verre trempé de 10 mm, couleur : Clair (C), Gris Fumé (G)

Structure : Acier laqué noir mat (équipée de patins réglables)

Dimension fermée : Ø 75 x h41,5 cm

Dimension ouverte : 130 x 75 x h41,5 cm

Poids Net : 55,5 kg

© Modèles déposés (Réf. INPI : 20231433)

 **COFFEE TABLE** CT525 / CT625

Top plate :

Ceramic over glass thickness 3 + 6 mm, colours : Argile (AR), Matt marble (MA), Steel dark (SD), Silver (SI), Titanium (TI), Clear oak (CC)

10 mm tempered glass, colours : Clear glass (C), Smoked grey glass (G)

Structure : Matt black lacquered steel (with built-in levellers)

Dimension closed : Ø 75 x H41,5 cm

Dimension open : 130 x 75 x H41,5 cm

Net Weight : 55,5 kgs

© Registered design (Réf INPI : 20231433)

 **COUCHTISCH** CT525 / CT625

Tischplatte :

Keramik auf Glas Stärke 3 + 6 mm, farben: zementgrau (AR), Marmoroptik matt (MA), rostbraun (SD), silver (SI), Titan (TI), eiche hell (CC)

10 mm starkem Temperglas, farben: Glas Klar (C), Glas grau getönt (G)

Gestell: Stahl schwarz matt lackiert (mit plastikcappe)

Abmessung geschlossen: Ø 75 x H41,5 cm

Abmessung geöffnet: 130 x 75 x H41,5 cm

Nettogewicht: 55,5 kg

© Registriertes Modell (INPI 20231433)

# AKANTE®

QUATTRO - IMOLA®



CT295TI



CT294SD



CT298AR



CT394SD



CT394CC



CT394MA



# QUATTRO - IMOLA®

## TABLE BASSE CT294 / CT295 / CT298 / CT394

4 plateaux tournants synchronisés

Dimension fermée : 80 x 80 x h45 cm

Dimension ouverte : 125 x 125 x h45 cm

Poids Net : CT298 / CT295 / CT294 : 59 kg

CT394 : 66 kg

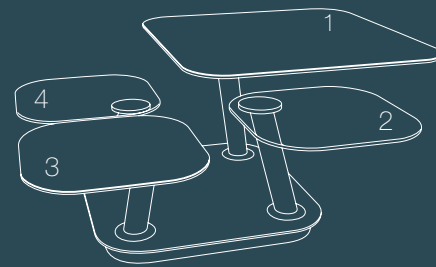

CT294 / CT295 / CT298

Plateau 1 et 3 : Céramique de 3 mm collée sur un verre de 6 mm d'épaisseur

Plateau 2 et 4 : Verre clair trempé 10 mm

Plateau 1 : 80 x 80 cm / Plateau 2, 3 et 4 : 40 x 40 cm

Céramiques AR / MA / SD / SI / TI / CC : argile / marbre mat / acier / silver / titane / chêne clair

CT298 : Pieds et base en acier laqué taupe mat (équipés de patins réglables)

CT295 : Pieds et base en acier laqué gris anthracite mat (équipés de patins réglables)

CT294 : Pieds en acier chromé, base en acier laqué noir mat (équipés de patins réglables)

CT394 : Pieds ajourés et base en acier laqué noir mat (équipés de patins réglables)

© Modèle déposé (Réf. INPI : 20190743 - 20231433)

## COFFEE TABLE CT294 / CT295 / CT298 / CT394

4 synchronised tops

Dimension closed : 80 x 80 x H45 cm

Dimension open : 125 x 125 x H45 cm

Net Weight : CT298 / CT295 / CT294 : 59 kgs

CT394 : 66 kgs



CT394

Plates 1 and 3 : Ceramic over glass thickness 3 + 6 mm

Plates 2 and 4 : Clear tempered glass thickness 10 mm

Plates 1 : 80 x 80 cm / Plates 2, 3 and 4 : 40 x 40 cm

Ceramics AR / MA / SD / SI / TI / CC : argile / matt marble / steel / silver / titanium / clear oak

CT298 : Legs and base in matt taupe painted steel (with built-in levellers)

CT295 : Legs and base in matt charcoal painted steel (with built-in levellers)

CT294 : Legs in chrome steel and base in matt black painted steel (with built-in levellers)

CT394 : Open-style legs and base in black lacquered steel (with built-in levellers)

© Registered design (INPI : 20190473 - 20231433)

## COUCHTISCH CT294 / CT295 / CT298 / CT394

4 synchronisierte Tischplatten

Abmessung geschlossen: 80 x 80 x H45 cm

Abmessung geöffnet: 125 x 125 x H45 cm

Nettogewicht: CT298 / CT295 / CT294: 59 kg

CT394: 66 kg

Platte 1 und 3: 3 mm Keramik verklebt auf 6 mm starkem Glas

Platte 2 und 4: 10 mm starkem Temperglas

Platte: 80 x 80 cm / Platte 2, 3 und 4: 40 x 40 cm

Keramik Erhältlich AR / MA / SD / SI / TI / CC: zementgrau / Marmoroptik matt / rostbraun / Silver / Titan / eiche hell

CT298: Füße und Bodenplatte Stahl taupe lackiert matt (mit plastikcappe)

CT295: Füße und Bodenplatte Stahl anthrazit lackiert matt (mit plastikcappe)

CT294: Füße Stahl verchromt und Bodenplatte Stahl schwarz lackiert matt (mit plastikcappe)

CT394: Durchbrochen Füße und Bodenplatte Stahl schwarz matt lackiert (mit plastikcappe)

# AKANTE®

RIVIERA®

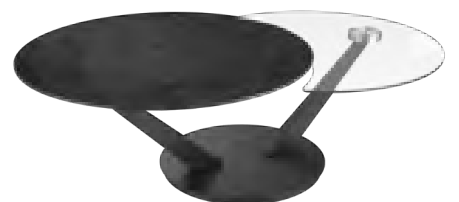
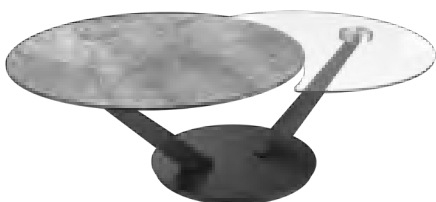
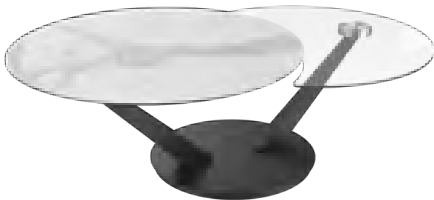

# RIVIERA<sup>®</sup>

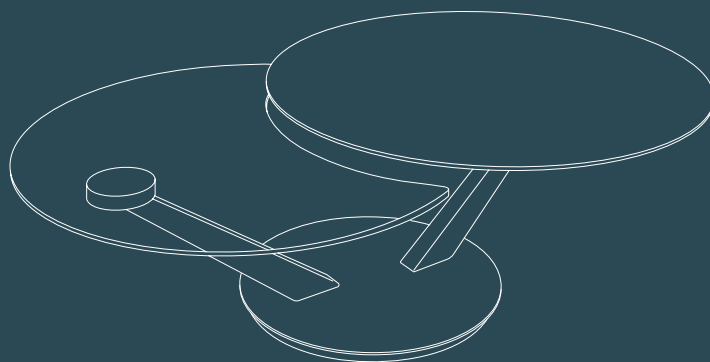

## TABLE BASSE

CT264

Plateau supérieur à mécanisme synchronisé en céramique de 3 mm collée sur un verre de 6 mm  
Plateau inférieur en verre trempé de 10 mm  
Piétement : Acier laqué noir mat (équipé de patins réglables)

Dimension fermée : Ø 80 x h40 cm  
Dimension ouverte : 125 x 80 x h40 cm  
Poids Net : 52 kg

CT264SI / AR / MA / SD / TI / CC :

Plateau céramique silver / argile / marbre mat / acier / titane / chêne clair

© Modèle déposé (Réf. INPI : 20215513)

## COFFEE TABLE

CT264

Main plate with synchronized system in ceramic over glass thickness 3 + 6 mm  
Tempered glass second plate 10 mm  
Legs : Black lacquered steel (with built-in levellers)

Dimension closed : Ø 80 x H40 cm  
Dimension open : 125 x 80 x H40 cm  
Net Weight : 52 kgs

CT264SI / AR / MA / SD / TI / CC :

Ceramic plate silver / clay / marble matt / steel / titanium / clear oak

© Registered design (INPI : 20215513)

## COUCHTISCH

CT264

Obere Platte aus 3 mm Keramik verklebt auf 6 mm starkem Glas mit synchronisiertem Mechanismus  
Untere Platte aus 10 mm starkem Temperglas  
Gestell aus schwarz matt lackiertem Stahl (mit plastikplatte)

Abmessung geschlossen: Ø 80 x H40 cm  
Abmessung geöffnet: 125 x 80 x H40 cm  
Nettogewicht: 52 kg

CT264SI / AR / MA / SD / TI / CC:

Ausführungen der Keramikplatte: silver / zementgrau / Marmoroptik matt / rostbraun / Titan / eiche hell

© Registriertes Modell (INPI : 20215513)

# AKANTE®

ROUND

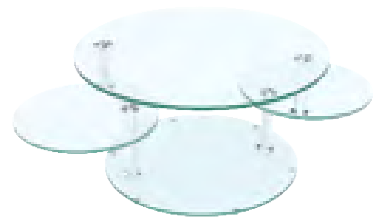

# ROUND

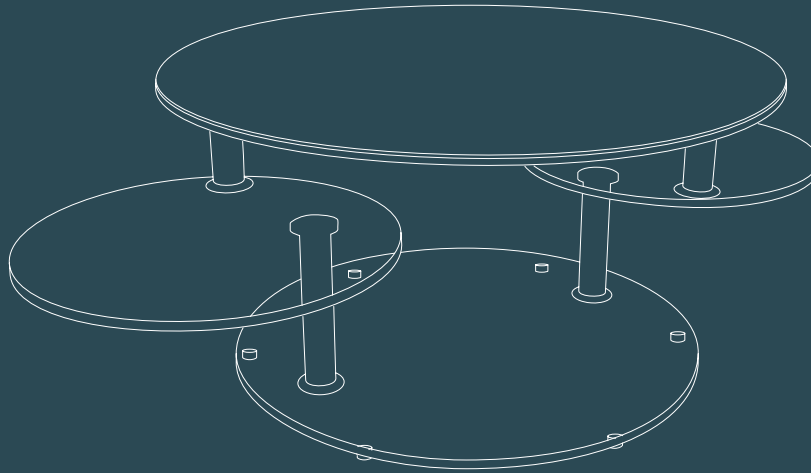

## TABLE BASSE

CT127

2 plateaux inférieurs pivotants  
Base et plateaux inférieurs en verre clair trempé de 10 mm  
Dimensions fermée : Ø 80 x h45 cm  
Dimensions ouverte : 118 x 80 x h45 cm  
Poids Net : 44 kg

CT127C : Plateau supérieur en verre clair trempé  
CT127AR : Plateau supérieur en céramique argile sur verre  
CT127SD : Plateau supérieur en céramique acier sur verre

## COFFEE TABLE

CT127

2 pivoting lower tops  
Top in tempered clear glass thickness 10 mm  
Dimensions closed : Ø 80 x H45 cm  
Dimensions opened : 118 x 80 x H45 cm  
Net Weight : 44 kgs

CT127C : Top in clear tempered glass  
CT127AR : Top in Argile ceramic over glass  
CT127SD : Top in Steel ceramic over glass

## COUCHTISCH

CT127

2 schwenkbare Tischplatten  
Oberplatte: Temperglas Dicke 10 mm  
Abmessung geschlossen: Ø 80 x h45 cm  
Abmessung geöffnet: 118 x 80 x h45 cm  
Nettogewicht: 44 kg

CT127C: Oberplatte aus getempertem Klarglas  
CT127AR: Oberplatte aus Keramikplatte in Zementgrau auf Glasplatte  
CT127SD: Oberplatte aus Keramikplatte in Rostbraun auf Glasplatte



# AKANTE®

SALVADOR®



# SALVADOR<sup>®</sup>

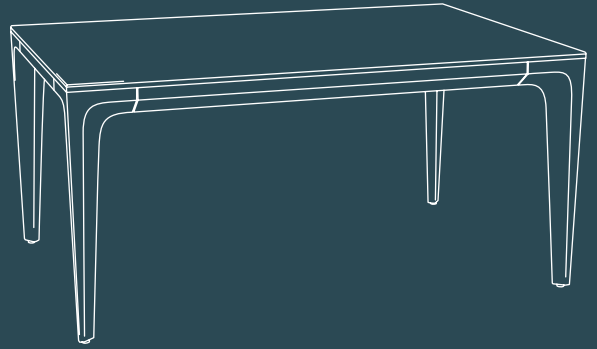
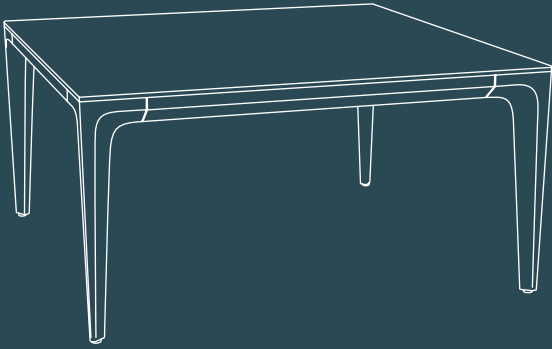

## TABLE BASSE      CT151 / CT153 / CT155

Plateau : Céramique de 3 mm collée sur un verre de 6 mm d'épaisseur, couleurs : Silver (SI), Titane (TI), Argile (AR)

Piètement : Acier et aluminium laqué

CT151 : Dimensions : 85 x 85 x h43 cm  
Poids Net : 28,64 kg

CT153 : Dimensions : 90 x 60 x h43 cm  
Poids Net : 23,64 kg

CT155 : Dimensions : 140 x 90 x h43 cm  
Poids Net : 45 kg

© Modèle déposé (Réf. INPI : 20234015)

## COFFEE TABLE      CT151 / CT153 / CT155

Main plate : 3 mm thick ceramic glued upon a 6 mm glass pane, colors : Silver (SI), Titanium (TI), Argile (AR)

Legs : Lacquered steel and aluminium

CT151 : Dimensions : 85 x 85 x h43 cm  
Net Weight : 28,64 kgs

CT153 : Dimensions : 90 x 60 x h43 cm  
Net Weight : 23,64 kgs

CT155 : Dimensions : 140 x 90 x h43 cm  
Net Weight : 45 kgs

© Registered design (INPI : 20234015)

## COUCHTISCH      CT151 / CT153 / CT155

Platte: 3 mm Keramik, geklebt auf 6 mm Glas, Farbe: Silver (SI), Titan (TI), Zementgrau (AR)

Gestell: Lackiertes Stahl und Aluminium

CT151: Abmessung: 85 x 85 x H43 cm  
Nettogewicht: 28,64 kg

CT153: Abmessung: 90 x 60 x H43 cm  
Nettogewicht: 23,64 kg

CT155: Abmessung: 140 x 90 x H43 cm  
Nettogewicht: 45 kg

© Registriertes Modell (INPI: 20234015)

# AKANTE®

SATELLITE®



# SATELLITE<sup>®</sup>



## TABLE BASSE

CT330

Plateau principal et tablette en céramique de 3 mm collée sur un verre de 6 mm  
Piétement : Acier laqué noir mat

Dimensions fermée : Ø 80 x h43 cm  
Dimensions ouverte : 80 x 110 x h43 cm  
Poids Net : 29 kg

**CT330SD** : Plateau principal en céramique acier et sa tablette en céramique argile

**CT330TI** : Plateau principal en céramique titane et sa tablette en céramique marbre mat

© Modèle déposé (Réf. INPI : 20200478)

## COFFEE TABLE

CT330

Main plate and tablettas in ceramic over glass thickness 3 + 6 mm - Legs : Black lacquered steel

Dimensions closed : Ø 80 x H43 cm  
Dimensions open : 80 x 110 x H43 cm  
Net Weight : 29 kgs

**CT330SD** : Main plate in steel ceramic with tablettas in argile ceramic

**CT330TI** : Main plate in titanium ceramic with tablettas in matt marble ceramic

© Registered design (INPI : 20200478)

## COUCHTISCH

CT330

Hauptplatte und Drehplatten aus Keramik auf Glas 3 + 6 mm - Ausführungen Gestell: Stahl schwarz matt lackiert

Abmessung geschlossen: Ø 80 x H43 cm  
Abmessung geöffnet: 80 x 110 x H43 cm  
Nettogewicht: 29 kg

**CT330SD**: Hautplatte aus Keramik rostbraun und eine Drehplatte Keramik zementgrau

**CT330TI**: Hautplatte aus Keramik Titan und eine Drehplatte Keramik Marmoroptik matt

© Registriertes Modell (INPI : 20200478)

## BOUT DE CANAPÉ

Plateau : Céramique de 3 mm collée sur un verre de 6 mm  
Piétement : Acier laqué noir mat

Céramiques **AR / SD / MA / TI / SI / CC** : argile / acier / marbre mat / titane / silver / chêne clair

**ET330** : Dimensions : Ø 55 x h50 cm  
Poids Net : 8 kg

**ET331** : Dimensions : Ø 55 x h60 cm  
Poids Net : 8 kg

## SIDE TABLE

Top : 3 mm argile ceramic over 6 mm glass  
Legs : Black lacquered steel

Ceramics **AR / SD / MA / TI / SI / CC** : argile / steel dark / matt marble / titanium / silver / clear oak

**ET330** : Dimensions : Ø 55 x H50 cm  
Net Weight : 8 kgs

**ET331** : Dimensions : Ø 55 x H60 cm  
Net Weight: 8 kgs

© Registered design (INPI : 20205317)

## BEISTELLTISCH

3 mm Keramikplatte auf 6 mm starkem Glas  
Gestell: Stahl schwarz matt lackiert

Keramik **AR / SD / MA / TI / SI / CC**: zementgrau / rostbraun / Marmoroptik matt / Titan / silver / eiche hell

**ET330**: Abmessung: Ø 55 x H50 cm  
Nettogewicht: 8 kg

**ET331**: Abmessung: Ø 55 x H60 cm  
Nettogewicht: 8 kg

# AKANTE®

SEVILLA - OLETTA - PARMA®



# SEVILLA - OLETTA - PARMA<sup>®</sup>

## TABLE BASSE CT497 / CT397 / CT697

Plateau supérieur : Céramique pleine masse de 11 mm, couleurs : marbre Marquina (**MM**), marbre Calcatta (**MC**), marbre Onyx bleu (**MO**), marbre Emperador (**ME**)

Plateau inférieur : Verre clair trempé, épaisseur 10 mm  
Structure équipée de roulettes en acier laqué noir mat

CT497/CT397 : Dimensions fermée : 88 x 75 x h42 cm  
Dimensions ouverte : 146 x 75 x h42 cm

CT697 : Dimensions fermée : 87 x 73 x h45 cm  
Dimensions ouverte : 145 x 73 x h45 cm

CT397 : Poids Net : 48 kg  
CT697 : Poids Net : 51 kg  
CT497 : Poids Net : 52,5 kg

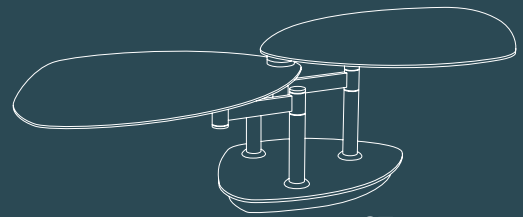

CT497

© Modèle déposé (Réf. INPI : 20222320/20231433)

## COFFEE TABLE CT497 / CT397 / CT697

Full body ceramic thickness 11 mm, colours : Marquina marble (**MM**), Calcatta marble (**MC**), Onyx blue marble (**MO**), Emperador marble (**ME**)

Lower plate : Clear tempered glass, thickness 10 mm  
Structure in mat black painting steel with wheels

CT497/CT397 : Dimension closed : 88 x 75 x h42 cm  
Dimension open : 146 x 75 x h42 cm

CT697 : Dimension closed : 87 x 73 x h45 cm  
Dimension open : 145 x 73 x h45 cm

CT397 : Net Weight : 48 kgs  
CT697 : Net Weight : 51 kgs  
CT497 : Net Weight : 52,5 kgs

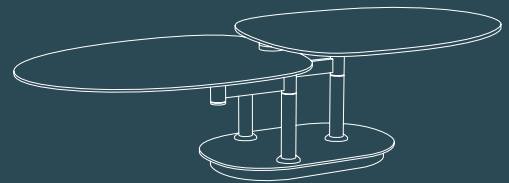

CT397

© Registered design (INPI : 20222320/20231433)

## COUCHTISCH CT497 / CT397 / CT697

11 mm dicke Vollkeramik, farben: Marmoroptik Marquina (**MM**), Marmoroptik Calcatta (**MC**), Marmoroptik Onyx blau (**MO**), Marmoroptik Emperador (**ME**)

Untere Platte aus getempertem Klarglas, Dicke 10 mm  
Gestell auf Rollen und Füße aus Stahl schwarz lackiert

CT497/CT397: Abmessung geschlossen: 88 x 75 x H42 cm  
Abmessung geöffnet: 146 x 75 x H42 cm

CT697: Abmessung geschlossen: 88 x 75 x H45 cm  
Abmessung geöffnet: 146 x 75 x H45 cm

CT397: Nettogewicht: 48 kg  
CT697: Nettogewicht: 51 kg  
CT497: Nettogewicht: 52,5 kg

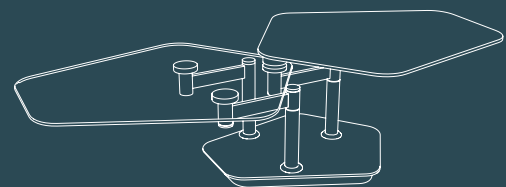

CT697

© Registriertes Modell (INPI : 20222320/20231433)

# AKANTE®

SIGMA - SIGMA ONE®



CT090B

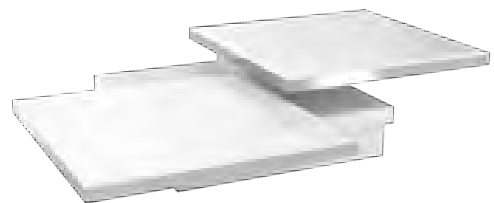

CT090W

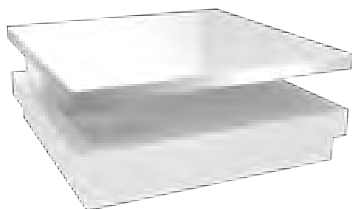

CT080LW

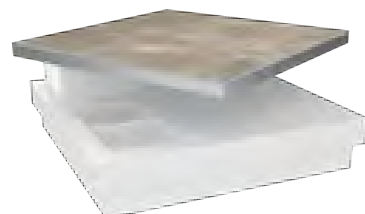

CT080AR



# SIGMA - SIGMA ONE<sup>®</sup>

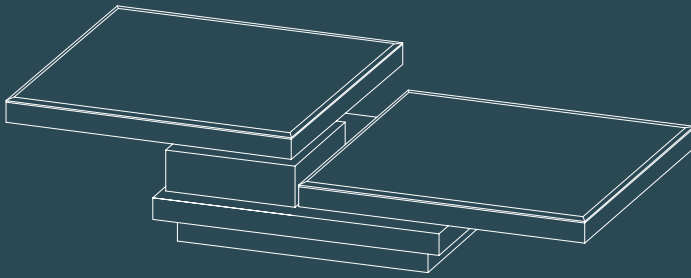

CT090

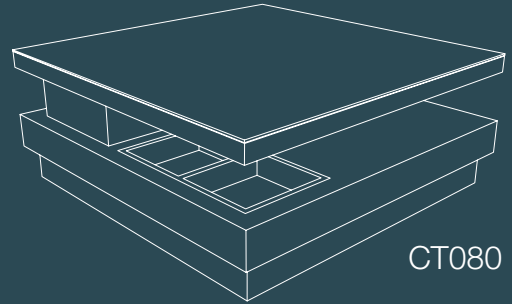

CT080

## TABLE DE SALON

Structure : Acier inoxydable poli ou brossé (équipée de patins réglables)  
Base MDF laqué (équipée de patins réglables)

### CT090W / CT090B :

Plateau en verre trempé laqué 8 mm blanc / noir

Dimension fermée : 120 x 80 x h33 cm  
Dimension ouverte : 160 x 160 x h33 cm  
Poids Net : 53 kg

### CT080LW / CT080AR :

Plateau en verre extra blanc trempé laqué blanc, épaisseur 8 mm / céramique de 3 mm sur verre de 6 mm marbre mat / argile

Dimension fermée : 80 x 80 x h35 cm  
Dimension ouverte : 120 x 80 x h35 cm  
Poids Net : 40 kg

© Modèle déposé (Réf. INPI : 20173908)

## COFFEE TABLE

Frame : Polished stainless steel or brushed (with built-in levellers)  
MDF base (with built-in levellers)

### CT090W / CT090B :

Top in 8 mm lacquered tempered glass white / black

Closed dimensions : 120 x 80 x H33 cm  
Opened dimensions : 160 x 160 x H33 cm  
Net Weight : 53 kgs

### CT080LW / CT080AR :

Top in 8 mm white lacquered tempered Crystal\* glass / 3 mm mat marble / argile ceramic over 6 mm glass

Closed dimensions : 80 x 80 x H35 cm  
Opened dimensions : 120 x 80 x H35 cm  
Net Weight : 40 kgs

© Registered design (INPI : 20173908)

## COUCHTISCH

Einfassung: Stahl glanzpoliert (mit plastikkappe)  
Korpus: MDF lackiert (mit plastikkappe)

### CT090W / CT090B:

Tischplatte 8 mm Temperglas weiß / schwarz lackiertes

Abmessung geschlossen: 120 x 80 x H33 cm  
Abmessung geöffnet: 160 x 160 x H33 cm  
Nettogewicht: 53 kg

### CT080LW / CT080AR:

Tischplatte: 8 mm starkes Temperglas extra-weiß / Keramik Marmoroptik matt / Zementgrau lackiertes auf Glas 3 + 6 mm

Abmessung geschlossen: 80 x 80 x H35 cm  
Abmessung geöffnet: 120 x 80 x H35 cm  
Nettogewicht: 40 kg

© Registriertes Modell (INPI 20173908)

\* Low iron glass



# AKANTE®

SILVERSTONE®



# SILVERSTONE<sup>®</sup>



Plateau supérieur :

Céramique de 3 mm collée sur un verre de 6 mm d'épaisseur, couleurs : Argile (AR), Marbre Mat (MA), Acier (SD), Silver (SI), Titane (TI), Chêne clair (CC)

Céramique pleine masse de 11 mm, couleurs : Marquina (MM), Calcatta (MC), Onyx bleu (MO)

Piètement : Acier laqué noir mat (équipé de patins réglables)

## TABLE BASSE

Pieds pleins : CT240 / CT241 / CT242 / CT243

Pieds ajourés : CT244 / CT245 / CT246 / CT247

Dimensions : 100 x 60 x h33 cm

h38 cm

h43 cm

h50 cm

Poids Net : 18 kg

## COIN CANAPÉ

Pieds pleins : ET240 / ET241 / ET242 / ET243

Pieds ajourés : ET244 / ET245 / ET246 / ET247

Dimensions : 60 x 36 x h33 cm

h38 cm

h43 cm

h50 cm

Poids Net : 8,5 kg

© Modèles déposés (Réf. INPI : 20231433)



Top plate :

Ceramic over glass thickness 3 + 6 mm, colours : Argile (AR), Matt marble (MA), Steel dark (SD), Silver (SI), Titanium (TI), Clear oak (CC)

Full body ceramic thickness 11 mm, colours : Marquina (MM), Calcatta (MC), Onyx bleu (MO)

Legs : Black lacquered steel legs (with built-in levellers)

## COFFEE TABLE

Solid legs : CT240 / CT241 / CT242 / CT243

Open-style legs : CT244 / CT245 / CT246 / CT247

Dimensions : 100 x 60 x H33 cm

H38 cm

H43 cm

H50 cm

Net weight : 18 kgs

## END TABLE

Solid legs : ET240 / ET241 / ET242 / ET243

Open-style legs : ET244 / ET245 / ET246 / ET247

Dimensions : 60 x 36 x H33 cm

H38 cm

H43 cm

H50 cm

Net weight : 8,5 kgs

© Registered design (Réf INPI : 20231433)



Tischplatte:

Keramik auf Glas Stärke 3 + 6 mm, farben: zementgrau (AR), Marmoroptik matt (MA), rostbraun (SD), silver (SI), Titan (TI), eiche hell (CC)

11 mm dicke Vollkeramik, farben: Marquina (MM), Calcatta (MC), Onyx bleu (MO)

Gestell: Füße aus Stahl Schwarz Lackiert (mit plastikkappe)

## COUCHTISCH

Tischbeine ganz: CT240 / CT241 / CT242 / CT243

Oder durchbrochen: CT244 / CT245 / CT246 / CT247

Abmessung: 100 x 60 x H33 cm

H38 cm

H43 cm

H50 cm

Nettogewicht: 18 kg

## BEISTELLTISCH

Tischbeine ganz: ET240 / ET241 / ET242 / ET243

Oder durchbrochen: ET244 / ET245 / ET246 / ET247

Abmessung: 60 x 36 x H33 cm

H38 cm

H43 cm

H50 cm

Nettogewicht: 8,5 kg

© Registriertes Modell (INPI 20231433)

# AKANTE®

SOPHIA®

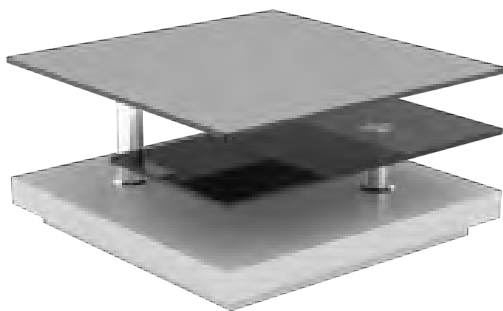

# SOPHIA<sup>®</sup>

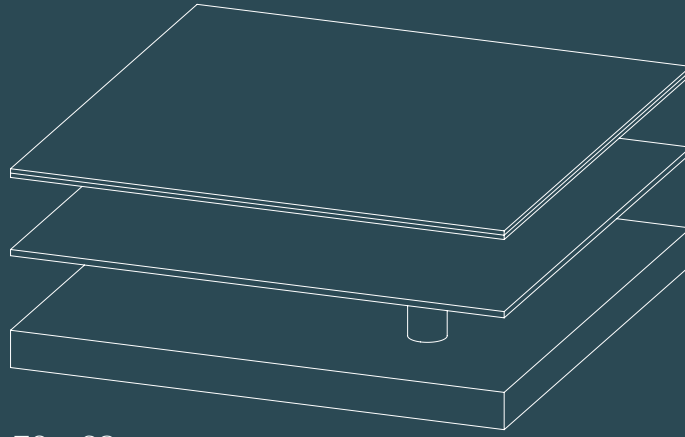

## TABLE BASSE

Dimension fermée : 72 x 72 x 38 cm  
Dimension ouverte : 95 x 72 x 38 cm  
Poids Net : 52 kg

### CT140CG :

Plateau supérieur en céramique grise sur verre épaisseur totale 14 mm  
Base en MDF laqué blanc mat, plateau intermédiaire en verre gris fumé

### CT141CH :

Table sur roulettes équipées de freins  
Plateau supérieur en MDF plaqué chêne  
Base en MDF plaqué noir, plateau intermédiaire en verre gris fumé

© Modèle déposé (Réf. INPI : 20161761)

## COFFEE TABLE

Dimension closed : 72 x 72 x 38 cm  
Dimension open : 95 x 72 x 38 cm  
Net Weight : 52 kgs

CT140CG : Base in white matt lacquered MDF, intermediary shelf in smoked grey glass  
Top in grey ceramic over glass total thickness : 14 mm

### CT141CH :

Wheel with caster brakes  
Top in MDF with oak veneer  
Base MDF with black veneer, intermediary shelf in smoked grey glass

© Registered design (INPI : 20161761)

## COUCHTISCH

Abmessung geschlossen: 72 x 72 x 38 cm  
Abmessung geöffnet: 95 x 72 x 38 cm  
Nettogewicht: 52 kg

CT140CG : Gestell aus MDF weiss lackiert matt, Zwischenplatte aus Glas grau getönt  
Oberplatte aus grauer Keramikplatte auf Glasplatte, Gesamtdicke : 14 mm

### CT141CH:

Tisch auf bremsbaren Laufrollen  
Oberplatte aus MDF Eichenfurnier  
Gestell aus schwarz furniertes MDF, Zwischenplatte aus Glas grau getönt

© Registriertes Modell (INPI 20161761)

# AKANTE®

STUTT GART®

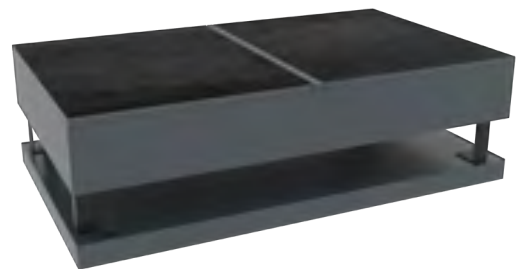
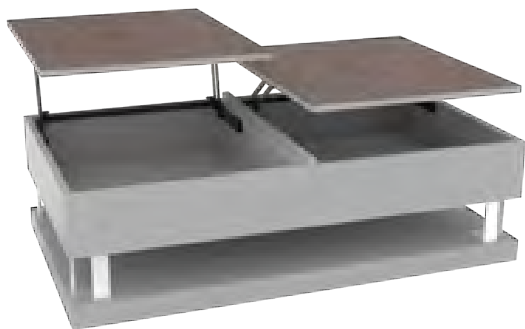

# STUTT GART®



## TABLE BASSE

CT257

CT257AR : 2 tablettes relevables en MDF recouvertes de céramique argile  
Structure en MDF laqué gris perle

CT257TI : 2 tablettes relevables en MDF recouvertes de céramique titane  
Structure en MDF laqué noir

Piètement : Acier inoxydable poli

Table sur roulettes équipées de freins

Dimensions : 120 x 70 x 38 cm  
Hauteur tablette déployée : 61,5 cm  
Poids Net : 63 kg

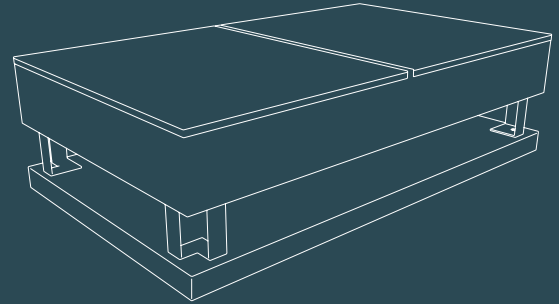

© Modèle déposé (Réf. INPI : 20173908)



## COFFEE TABLE

CT257

CT257AR : 2 MDF adjustable trays covered with argile ceramic  
Structure in pearl grey lacquered MDF

CT257TI : 2 MDF adjustable trays covered with titanium ceramic  
Structure in black lacquered MDF

Legs : Polished stainless steel

Wheels with caster brakes

Dimensions : 120 x 70 x 38 cm  
Tray height when lifted up : 61,5 cm  
Net Weight : 63 kgs

© Registered design (INPI : 20173908)



## COUCHTISCH

CT257

CT257AR: 2 aufklappbare zementgraue Keramikplatten auf MDF Korpus  
aus MDF perlgrau lackiert

CT257TI: 2 aufklappbare Titan Keramikplatten auf MDF Korpus  
aus schwarz lackiertem MDF

Gestell: Tischsäulen aus Edelstahl

auf bremsbaren Laufrollen

Abmessung: 120 x 70 x 38 cm  
Höhe bei aufgeklappter Ablage: 61,5 cm  
Nettogewicht: 63 kg

© Registriertes Modell (INPI : 20173908)

# AKANTE®

SUMATRA®



# SUMATRA®

🇫🇷 Plateau : Céramique marbre noir (BM) pleine masse de 12 mm  
ou céramique marbre Marquina (MM) pleine masse de 11 mm  
Piètement : acier laqué noir mat

## TABLE BASSE CT800BM / MM

Dimension : 120 x 70 x h38 cm

Poids Net : 32 kg

## BOUT DE CANAPÉ ET800BM / MM

Dimension : 50 x 50 x h50 cm

Poids Net : 13 kg

## CONSOLE ST800BM / MM

Dimension : 120 x 35 x h75 cm

Poids Net : 22 kg

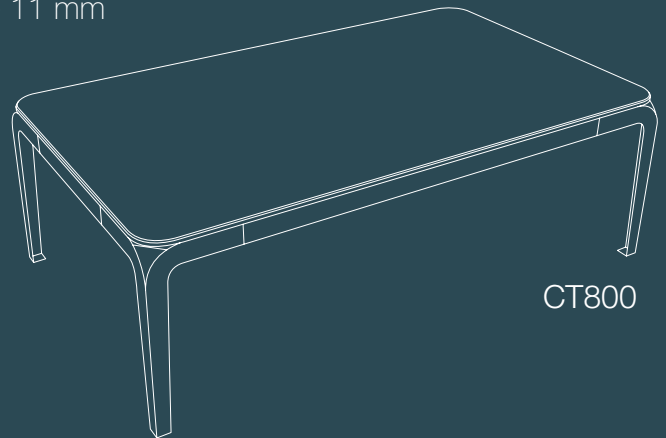

CT800

© Modèle déposé (Réf. INPI : 20205317)

🇬🇧 Main plate : Black marble (BM) ceramic thickness 12 mm  
or Marquina marble (MM) ceramic thickness 11 mm  
Legs : Black lacquered steel

## COFFEE TABLE CT800BM / MM

Dimension : 120 x 70 x H38 cm

Net Weight : 32 kgs

## SIDE TABLE ET800BM / MM

Dimension : 50 x 50 x H50 cm

Net Weight : 13 kgs

## CONSOLE TABLE ST800BM / MM

Dimension : 120 x 35 x H75 cm

Net Weight : 22 kgs



ET800

© Registered design (INPI : 20205317)

🇩🇪 Keramikplatte: Schwarze Marmoroptik (BM) Stärke 12 mm  
oder Marquina Marmoroptik (MM) Stärke 11 mm  
Gestell: Stahl schwarz lackiert

## COUCHTISCH CT800BM / MM

Abmessung: 120 x 70 x h38 cm

Nettogewicht: 32 kg

## BEISTELLTISCH ET800BM / MM

Abmessung: 50 x 50 x h50 cm

Nettogewicht: 13 kg

## KONSOLE ST800BM / MM

Abmessung: 120 x 35 x h75 cm

Nettogewicht: 22 kg



ST800

© Registriertes Modell (INPI : 20205317)



# AKANTE®

TALIA



# TALIA

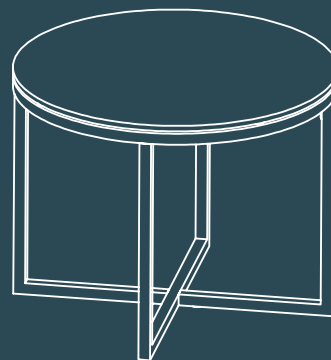
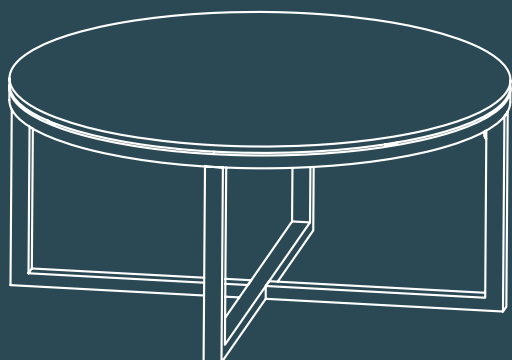

 Plateau : Verre 10 mm disponible en plusieurs teintes ou céramique de 3 mm collée sur verre de 6 mm ou céramique pleine masse de 11 mm

Céramique AR / SD / TI / MA / SI / MM / MC / MO / CC : Argile / Acier / Titane / Marbre mat / Silver / Marquina / Calcatta / Onyx Bleu / Chêne clair  
MB : maille d'acier

TABLE BASSE CT022 / 23

Dimensions : Ø 90 x 40 cm  
Poids Net : 26 kg

CT022 : Structure en acier laqué noir mat  
CT023 : Structure acier inoxydable poli

BOUT DE CANAPÉ ET022 / 23

Dimensions : Ø 55 x 45 cm  
Poids : 6 kg

ET022 : Structure en acier laqué noir mat  
ET023 : Structure acier inoxydable poli

 10 mm tempered glass top available in several tints or 3 mm Argile ceramics over 6 mm glass or full body ceramic thickness 11 mm

Ceramic AR / SD / MA / TI / SI / MM / MC / MO / CC : Argile / Steel dark / Matt Marble / Titanium / silver / Marquina marble / Calcatta marble / Blue Onyx marble / Clear oak  
MB : steel mesh

COFFEE TABLE CT022 / 23

Dimensions : Ø 90 x 40 cm  
Net Weight : 26 kgs

CT022 : Frame in black lacquered steel  
CT023 : Frame in polished stainless steel

END TABLE ET022 / 23

Dimensions : Ø 55 x 45 cm  
Net Weight : 6 kgs

ET022 : Frame in black lacquered steel  
ET023 : Frame in polished stainless steel

 10 mm starke Glasplatte oder 3 mm Keramikplatte verklebt auf 6 mm starkem Glas oder 11 mm dicke Vollkeramik

Keramik AR / SD / MA / TI / SI / MM / MC / MO / CC : zementgrau / rostbraun / Marmoroptik matt / Titan / silver / Marmoroptik Calcatta / Marmoroptik Marquina matt / Marmoroptik Onyx blau / eiche hell  
MB: Stahlgeflecht

COUCHTISCH CT022 / 23

Abmessung: Ø 90 x 40 cm  
Nettogewicht : 26 kg

CT022: Gestell Stahl schwarz lackiert  
CT023: Gestell Stahl poliert

BEISTELLTISCH ET022 / 23

Abmessung: Ø 55 x 45 cm  
Nettogewicht: 6 kg

ET022: Gestell Stahl schwarz lackiert  
ET023: Gestell Stahl poliert

# AKANTE®

TAMARA



# TAMARA

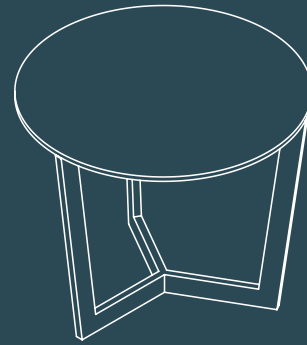
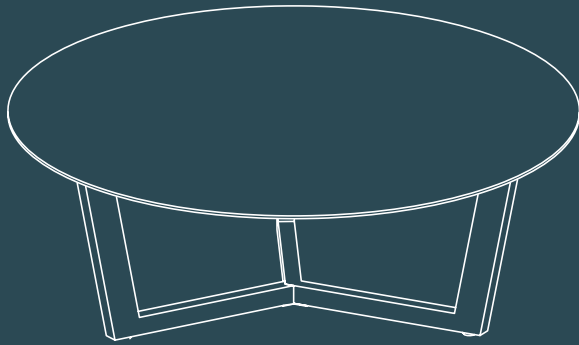

🇫🇷 Plateau : Verre 10 mm disponible en plusieurs teintes ou céramique de 3 mm collée sur verre de 6 mm ou céramique pleine masse de 11 mm

Céramique AR / SD / TI / MA / SI / MM / MC / MO / CC : argile / acier / titane / marbre mat / silver / Marquina / Calcatta / Onyx Bleu / chêne clair  
MB : maille d'acier

TABLE BASSE CT033

Dimensions : Ø 90 x 40 cm  
Poids Net : 26 kg

CT033 : Structure acier inoxydable poli  
CT053 : Structure acier laqué noir mat

BOUT DE CANAPÉ ET033

Dimensions : Ø 55 x 45 cm  
Poids Net : 10 kg

ET033 : Structure acier inoxydable poli  
ET053 : Structure acier laqué noir mat

🇬🇧 10 mm tempered glass top available in several tints or 3 mm Argile ceramics over 6 mm glass or full body ceramic thickness 11 mm

Ceramic AR / SD / MA / TI / SI / MM / MC / MO / CC : argile / steel dark / Matt Marble / titanium / silver / Marquina marble / Calcatta marble / Blue Onyx marble / clear oak  
MB : steel mesh

COFFEE TABLE CT033

Dimensions : Ø 90 x 40 cm  
Net Weight : 26 kgs

CT033 : Frame in polished stainless steel  
CT053 : Frame in black lacquered steel

SIDE TABLE ET033

Dimensions : Ø 55 x 45 cm  
Net Weight : 10 kgs

ET033 : Frame in polished stainless steel  
ET053 : Frame in black lacquered steel

🇩🇪 10 mm starke Glasplatte oder 3 mm Keramikplatte verklebt auf 6 mm starkem Glas oder 11 mm dicke Vollkeramik

Keramik AR / SD / MA / TI / SI / MM / MC / MO / CC: zementgrau / rostbraun / Marmoroptik matt / Titan / silver / Marmoroptik Calcatta / Marmoroptik Marquina matt / Marmoroptik Onyx blau / eiche hell  
MB: Stahlgeflecht

COUCHTISCH CT033

Abmessung: Ø 90 x 40 cm  
Nettogewicht: 26 kg

CT033: Gestell Stahl poliert  
CT053: Gestell Stahl schwarz lackiert

BEISTELLTISCH ET033

Abmessung: Ø 55 x 45 cm  
Nettogewicht: 10 kg

ET033: Gestell Stahl poliert  
ET053: Gestell Stahl schwarz lackiert

# AKANTE®

TELMA

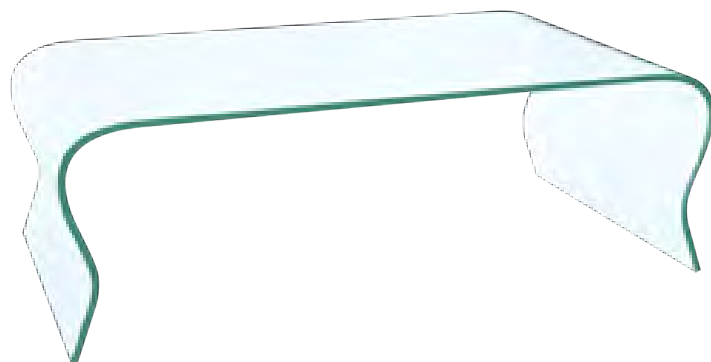

# TELMA

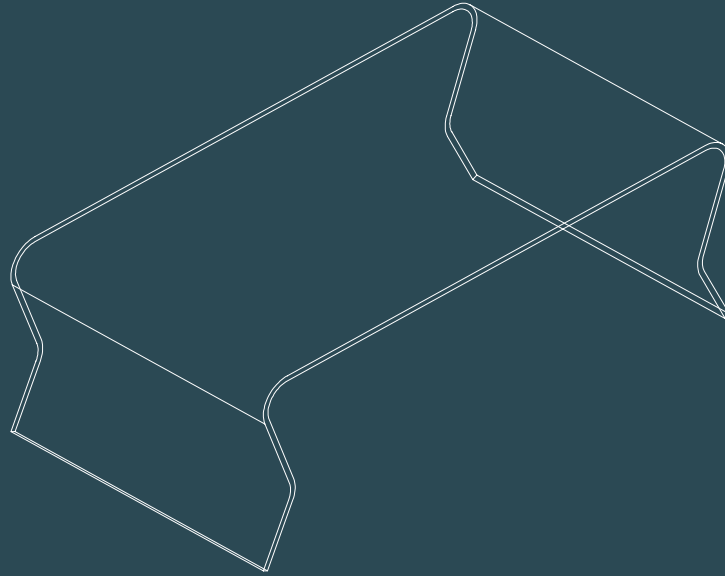

 TABLE BASSE

CT067

Verre clair courbé à chaud haute résistance

Epaisseur : 12 mm

Dimensions : 120 x 65 x h40 cm

Poids Net : 39 kg

 COFFEE TABLE

CT067

High resistance hot bent clear glass

Thickness : 12 mm

Dimensions : 120 x 65 x H40 cm

Net Weight : 39 kgs

 COUCHTISCH

CT067

Hochbeständiges heißgebogenes Klarglas

Materialstärke: 12 mm

Abmessung: 120 x 65 x H40 cm

Nettogewicht: 39 kg

# AKANTE®

THALÈS



# THALÈS

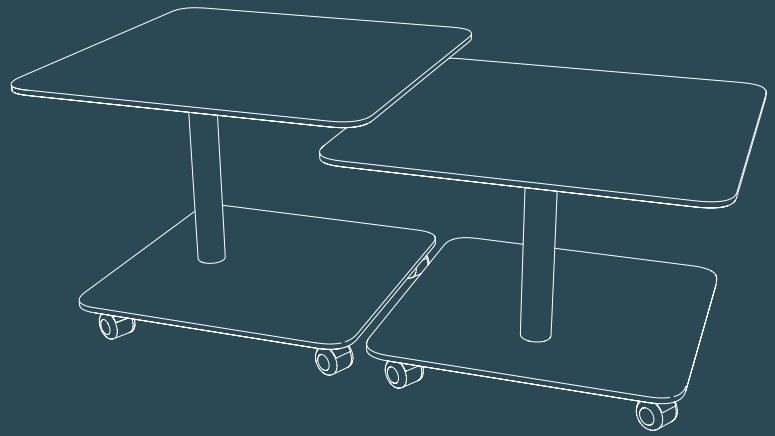

 COIN CANAPE ET160 / ET162

Plateaux : Céramique Titane (TI) de 3 mm collée sur un verre de 6 mm d'épaisseur  
Verre Gris fumé (G) de 10 mm d'épaisseur  
Structure : Acier laqué noir mat  
Roulettes équipées de freins

ET160 : Dimensions : 60 x 60 x h40 cm  
Poids Net : 26 kg

ET162 : Dimensions : 60 x 60 x h46 cm  
Poids Net : 26 kg

 END TABLE ET160 / ET162

Top plate : Ceramic Titanium (TI) over glass thickness 3 + 6 mm  
10 mm Smocked grey glass (G)  
Structure : Matt black lacquered steel  
Wheels with caster brakes

ET160 : Dimensions : 60 x 60 x H40 cm  
Net Weight : 26 kgs

ET162 : Dimensions : 60 x 60 x H46 cm  
Net Weight : 26 kgs

 BEISTELLTISCH ET160 / ET162

Tischplatte: Keramik Titan (TI) auf Glas 3+6 mm  
10 mm Glas grau getönt (G)  
Struktur: Schwartz lackieren Stahl  
Rollen mit Bremsen ausgestattet

ET160: Abmessung: 60 x 60 x H40 cm  
Nettogewicht: 26 kg

ET162: Abmessung: 60 x 60 x H46 cm  
Nettogewicht: 26 kg



# AKANTE®

TORINO®



# TORINO<sup>®</sup>

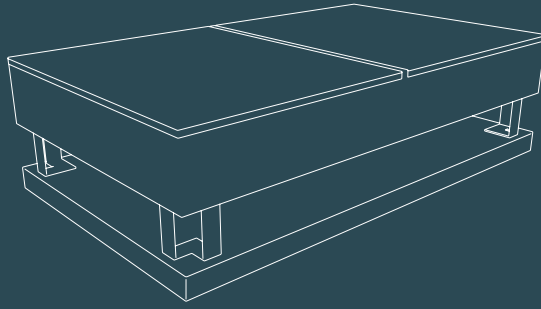

TABLE BASSE

CT357

CT357MC : 2 tablettes relevables en MDF recouvertes de céramique pleine masse marbre Calcata de 11 mm d'épaisseur

Structure et base en MDF laqué taupe

Table sur roulettes équipées de freins

Piètement : Acier inoxydable poli

Dimensions : 120 x 70 x h38 cm

Hauteur tablette déployée : 61,5 cm

Poids Net : 68,3 kg

© Modèle déposé (Réf. INPI : 20173908)



COFFEE TABLE

CT357

CT357MC : 2 MDF adjustable trays covered in 11 mm thick Calcata marble full body ceramic

Structure in taupe lacquered MDF

Wheels with caster brakes

Legs : Polished stainless steel

Dimensions : 120 x 70 x h38 cm

Tray height when lifted up : 61,5 cm

Net Weight : 68,3 kgs

© Registered design (INPI : 20173908)



COUCHTISCH

CT357

CT357MC: 2 aufklappbare, 11mm dicke Keramikplatten der Marmoroptik Calcata auf MDF Korpus

Basis aus taupefarbenen lackiertem MDF

Tisch auf Rollen mit Bremsen

Gestell: Polierter rostfreier Stahl

Abmessung: 120 x 70 x H38 cm

Höhe bei aufgeklappter Ablage: 61,5 cm

Nettogewicht: 68,3 kg

© Registriertes Modell (INPI: 20173908)

# AKANTE®

## TOSCA RONDE



# TOSCA RONDE

 Plateau supérieur céramique sur verre, épaisseur 3 + 6 mm  
ou céramique pleine masse de 11 mm  
Pieds en acier peinture époxy noir mat (équipés de patins réglables)

Céramiques AR / SD / TI / MA / SI / MM / MC / MO / CC :  
argile / acier / titane / marbre mat / silver / Marquina / Calcatta /  
Onyx Bleu / chêne clair

## TABLE BASSE

Pieds pleins : CT207 / CT208 / CT211 / CT229  
Pieds ajourés : CT407 / CT408 / CT411 / CT429

Dimensions : Ø 70 x h33 cm  
h38 cm  
h43 cm  
h50 cm

Poids Net : 15 kg



## BOUT DE CANAPÉ

Pieds pleins : ET204 / ET205 / ET206 / ET207  
ET208 / ET209 / ET213 / ET229  
Pieds ajourés : ET404 / ET405 / ET406 / ET407  
ET408 / ET409 / ET413 / ET429

Dimensions : Ø 50 ou Ø 40 x h33 cm  
h38 cm  
h43 cm  
h50 cm

Poids Net : 10 kg

 Top plate ceramic over glass thickness 3 + 6 mm  
or full body ceramic thickness 11 mm  
Black epoxy painted steel legs (with built-in levellers)

Ceramics AR / SD / MA / TI / SI / MM / MC / MO : argile / steel dark / Matt Marble /  
titanium / silver / Marquina marble / Calcatta marble / Blue Onyx marble / Clear oak

## COFFEE TABLE

Solid legs : CT207 / CT208 / CT211 / CT229  
Open-style legs : CT407 / CT408 / CT411 / CT429

Dimensions : Ø 70 x H33 cm  
H38 cm  
H43 cm  
H50 cm

Net weight : 15 kgs

## SIDE TABLE

Solid legs : ET204 / ET205 / ET206 / ET207  
ET208 / ET209 / ET213 / ET229  
Open-style legs : ET404 / ET405 / ET406 / ET407  
ET408 / ET409 / ET413 / ET429

Dimensions : Ø 50 ou Ø 40 x H33 cm  
H38 cm  
H43 cm  
H50 cm

Net weight : 10 kgs

 Obere Platte aus Keramik auf Glas Stärke 3 + 6 mm  
oder 11 mm dicke Vollkeramik  
Gestell Stahl pulverbeschichtet schwarz matt (mit plastikkappe)

Keramiken AR / SD / MA / TI / SI / MM / MC / MO / CC: zementgrau / rostbraun / Marmoroptik  
matt / Titan / silver / Marmoroptik Calcatta / Marmoroptik Marquina matt / Marmoroptik Onyx blau /  
eiche hell

## COUCHTISCH

Tischbeine ganz: CT207 / CT208 / CT211 / CT229  
Oder durchbrochen: CT407 / CT408 / CT411 / CT429

Abmessung: Ø 70 x H33 cm  
H38 cm  
H43 cm  
H50 cm

Nettogewicht: 15 kg

## BEISTELLTISCH

Tischbeine ganz: ET204 / ET205 / ET206 / ET207  
ET208 / ET209 / ET213 / ET229  
Oder durchbroche: ET404 / ET405 / ET406 / ET407  
ET408 / ET409 / ET413 / ET429

Abmessung: Ø 50 ou Ø 40 x H33 cm  
H38 cm  
H43 cm  
H50 cm

Nettogewicht: 10 kg

# AKANTE®

TWIST®



# TWIST<sup>®</sup>

## BOUT DE CANAPÉ

Plateau supérieur en verre trempé de 10 mm ou en céramique épaisseur 3 + 6 mm.  
Vaste choix de finitions pour le plateau supérieur  
Structure : acier inoxydable poli, acier inoxydable brossé ou acier laqué noir mat

ET034 / ET054 :

Dimensions : 48 x 48 x h35,8 cm - Poids Net : 10 kg

ET035 / ET038 / ET055 :

Dimensions : 48 x 48 x h45,8 cm - Poids Net : 11 kg

ET040 / ET041 / ET056 :

Dimensions : 48 x 48 x h56 cm - Poids Net : 11,5 kg

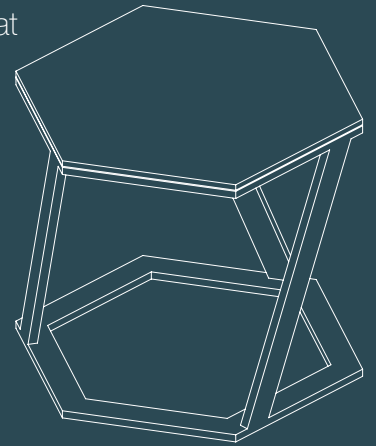

© Modèle déposé (Réf. INPI : 20142312)

## SIDE TABLE

Top in ceramic over glass 3 + 6 mm or in tempered clear glass thickness 10 mm.  
Large choice of finishes for tops and shelves  
Legs : Polished stainless, brushed stainless steel, black lacquered steel

ET034 / ET054 :

Dimensions : 48 x 48 x H35,8 cm - Net Weight : 10 kgs

ET035 / ET038 / ET055 :

Dimensions : 48 x 48 x H45,8 cm - Net Weight : 11 kgs

ET040 / ET041 / ET056 :

Dimensions : 48 x 48 x H56 cm - Net Weight : 11,5 kgs

© Registered design (INPI : 20142312)

## BEISTELLTISCH

Oberplatte: Keramik auf Glas 3 + 6 mm oder Temperglas Dicke 10 mm.  
Große Auswahl an Ausführungen für die oberen und unteren Tischplatte  
Gestell: Edelstahl poliert, edelstahl gebürstet, edelstahl Schwarz Lackiert

ET034 / ET054:

Abmessung: 48 x 48 x H35,8 cm - Nettogewicht: 10 kg

ET035 / ET038 / ET055:

Abmessung: 48 x 48 x H45,8 cm - Nettogewicht: 11 kg

ET040 / ET041 / ET056:

Abmessung: 48 x 48 x H56 cm - Nettogewicht: 11,5 kg

© Registriertes Modell (INPI 20142312)

# AKANTE®

VALENTINA®



# VALENTINA<sup>®</sup>



## Plateau supérieur :

Céramique de 3 mm collée sur un verre de 6 mm d'épaisseur, couleurs : Argile (AR),  
Marbre Mat (MA), Acier (SD), Silver (SI), Titane (TI), Chêne clair (CC)

Céramique pleine masse de 11 mm, couleurs : Marquina (MM), Calcatta (MC), Onyx bleu (MO)  
Verre trempé de 10 mm, couleur : Cristallin (R), Gris Fumé (G)

Piètement : Acier laqué noir mat

### TABLE BASSE

CT174 / CT175

### BOUT DE CANAPÉ

ET175

CT174 : Dimensions : Ø 75 x h45 cm  
Poids Net : 18 kg

Dimensions : Ø 55 x h50 cm  
Poids Net : 12 kg

CT175 : Dimensions : Ø 90 x h40 cm  
Poids Net : 26 kg

© Modèle déposé (Réf. INPI : 20215513)

## Top plate :

Ceramic over glass thickness 3 + 6 mm, colours : Argile (AR), Matt marble (MA), Steel dark (SD),  
Silver (SI), Titanium (TI), Clear oak (CC)

Full body ceramic thickness 11 mm, colours : Marquina (MM), Calcatta (MC), Onyx blue (MO)  
10 mm tempered glass, colours : Crystal glass (R), Smoked grey glass (G)

Legs : Black lacquered steel

### COFFEE TABLE

CT174 / CT175

### SIDE TABLE

ET175

CT174 : Dimensions : Ø 75 x H45 cm  
Net Weight : 18 kgs

Dimensions : Ø 55 x H50 cm  
Net Weight : 12 kgs

CT175 : Dimensions : Ø 90 x H40 cm  
Net Weight : 26 kgs

© Registered design (INPI : 20215513)

## Tischplatte:

Keramik auf Glas Stärke 3 + 6 mm, farben: zementgrau (AR), Marmoroptik matt (MA), rostbraun (SD),  
silver (SI), Titan (TI), eiche hell (CC)

11 mm dicke Vollkeramik, farben: Marquina (MM), Calcatta (MC), Onyx blau (MO)  
10 mm starkem Temperglas, farben: Glas ultraklar (R), Glas grau getönt (G)

Gestell aus schwarz matt lackiertem Stahl

### COUCHTISCH

CT174 / CT175

### BEISTELLTISCH

ET175

CT174: Abmessung: Ø 75 x H45 cm  
Nettogewicht: 18 kg

Abmessung: Ø 55 x H50 cm  
Nettogewicht: 12 kg

CT175: Abmessung: Ø 90 x H40 cm  
Nettogewicht: 26 kg

© Registriertes Modell ( INPI: 20215513)



# AKANTE®

VENEZIA®

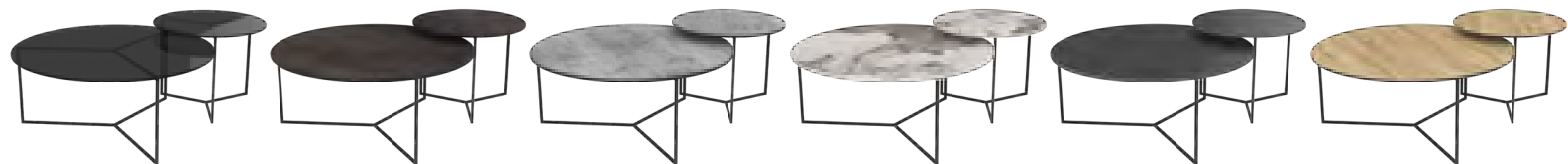

# ENEZIA<sup>®</sup>

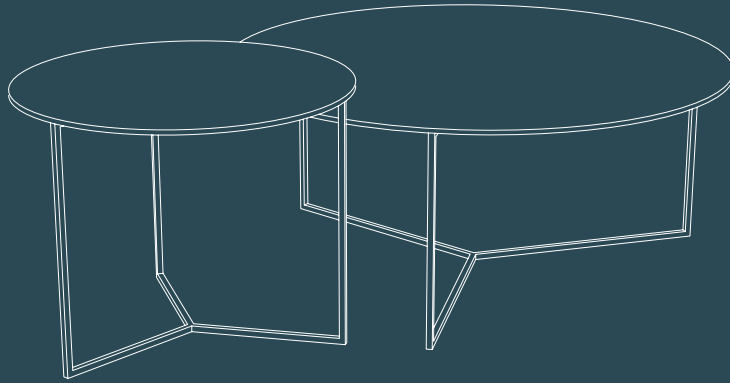

## 🇫🇷 Plateau supérieur :

Céramique de 3 mm collée sur un verre de 6 mm d'épaisseur, couleurs : Argile (AR), Marbre Mat (MA), Acier (SD), Silver (SI), Titane (TI), Chêne clair (CC)

Céramique pleine masse de 11 mm, couleurs : Marquina (MM), Calcatta (MC), Onyx bleu (MO)

Verre trempé de 10 mm, couleur : Cristallin (R), Gris Fumé (G)

Piètement : Acier laqué noir mat

### TABLE BASSE

CT440 / CT450

Dimensions : Ø75 ou 90 x h38 cm

Poids Net : 22 kg / 26 kg

### BOUT DE CANAPÉ

ET450

Dimensions : Ø55 x h43 cm

Poids Net : 9 kg

© Modèle déposé (Réf. INPI : 20215513)

## 🇬🇧 Top plate :

Ceramic over glass thickness 3 + 6 mm, colours : Argile (AR), Matt marble (MA), Steel dark (SD), Silver (SI), Titanium (TI), Clear oak (CC)

Full body ceramic thickness 11 mm, colours : Marquina (MM), Calcatta (MC), Onyx blue (MO)

10 mm tempered glass, colours : Crystal glass (R), Smoked grey glass (G)

Legs : Black lacquered steel

### COFFEE TABLE

CT440 / CT450

Dimensions : Ø75 or 90 x H38 cm

Net Weight : 22 kgs / 26 kgs

### SIDE TABLE

ET450

Dimensions : Ø55 x H43 cm

Net Weight : 9 kgs

© Registered design (INPI : 20215513)

## 🇩🇪 Tischplatte:

Keramik auf Glas Stärke 3 + 6 mm, farben: zementgrau (AR), Marmoroptik matt (MA), rostbraun (SD), silver (SI), Titan (TI), eiche hell (CC)

11 mm dicke Vollkeramik, farben: Marquina (MM), Calcatta (MC), Onyx blau (MO)

10 mm starkem Temperglas, farben : Glas ultraklar (R), Glas grau getönt (G)

Gestell: Stahl schwarz matt lackiert

### COUCHTISCH

CT440 / CT450

Abmessung: Ø75 oder 90 x H38 cm

Nettogewicht: 22 kg / 26 kg

### BEISTELLTISCH

ET450

Abmessung: Ø55 x h43 cm

Nettogewicht: 9 kg

© Registriertes Modell (INPI : 20215513)

# AKANTE®

ARES - VENUS

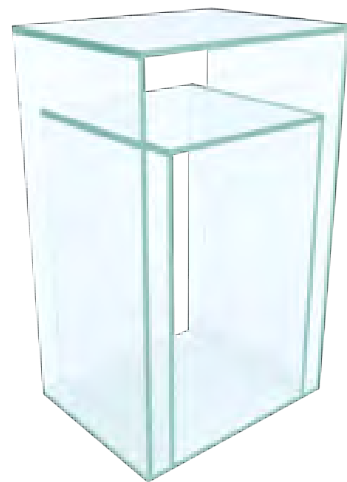

# ARES - VENUS

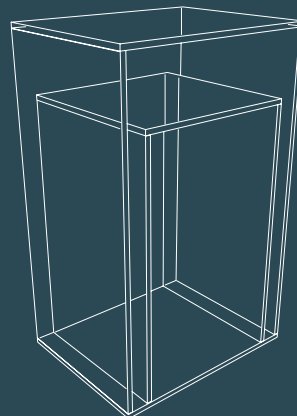
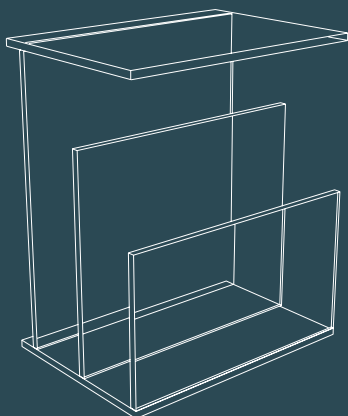

## BOUT DE CANAPÉ ET605C

Verre collé épaisseur : 10 mm

Dimensions : 25 x 35 x 42 cm

Poids Net : 10 kg

Charge maximum supportée : 5 kg

## BOUT DE CANAPÉ ET600C

Verre collé épaisseur : 8 mm

Dimensions : 25 x 32 x 52 cm

Poids Net : 12 kg

Charge maximum supportée : Tablette supérieur 5 kg  
Tablette intermédiaire 10 kg  
Base 10 kg

## SIDE TABLE ET605C

Glued glass thickness : 10 mm

Dimensions : 25 x 35 x 42 cm

Net Weight : 10 kgs

Maximum load : 5 kgs

## SIDE TABLE ET600C

Glued glass thickness : 8 mm

Dimensions : 25 x 32 x 52 cm

Net Weight : 12 kgs

Maximum load : Top 5 kgs  
Middle glass 10 kgs  
Bottom glass 10 kgs

## BEISTELLTISCH ET605C

Verklebtes Glas, 10 mm Stärke

Abmessung: 25 x 35 x 42 cm

Nettogewicht: 10 kg

Max. Belastbarkeit: 5 kg

## BEISTELLTISCH ET600C

Verklebtes Glas, 8 mm Stärke

Abmessung: 25 x 32 x 52 cm

Nettogewicht: 12 kg

Max. Belastbarkeit: Oberplatte 5 kg  
Zwischenplatte 10 kg  
Untere Platte 10 kg

# AKANTE®

VERTIGO - GRAVITY®



CT346SD



CT346TI

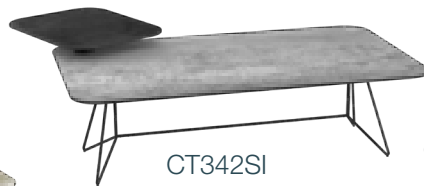

CT342SI



CT343SD



CT343TI



# VERTIGO - GRAVITY<sup>®</sup>

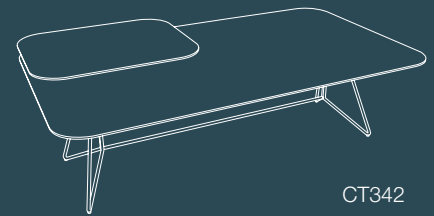

CT342

## TABLE BASSE

CT342 - CT343 / CT346

Plateau principal et tablettes en céramique de 3 mm collée sur un verre de 6 mm  
Piétement : Acier laqué noir mat

Dimension fermée : 130 x 75 x h43 cm

Dimension ouverte : **CT342** : 161 x 75 x h43 cm

**CT343/346** : 193 x 75 x h43 cm

Poids Net : 39 kg

**CT342SD** : Plateau principal en céramique acier et sa tablette en céramique argile

**CT342TI** : Plateau principal en céramique titane et sa tablette en céramique marbre mat

**CT342SI** : Plateau principal en céramique silver et sa tablette en céramique titane

**CT343/346SD** : Plateau principal en céramique acier et ses 2 tablettes en céramique argile

**CT343/346TI** : Plateau principal en céramique titane et ses 2 tablettes en céramique marbre mat

© Modèles déposés (Réf. INPI : 20200478 - 20205317)

## COFFEE TABLE

CT342 - CT343 / CT346

Main plate and tablettes in ceramic over glass thickness 3+6mm

Legs : Black lacquered steel

Dimension closed : 130 x 75 x H43 cm

Dimension open : **CT342** : 161 x 75 x H43 cm

**CT343/346** : 193 x 75 x H43 cm

Net Weight : 39 kgs

**CT342SD** : Main plate in steel ceramic with tablette in argile ceramic

**CT342TI** : Main plate in titanium ceramic with tablette in matt marble ceramic

**CT342SI** : Main plate in silver ceramic with tablette in titanium ceramic

**CT343/346SD** : Main plate in steel ceramic with 2 tablettes in argile ceramic

**CT343/346TI** : Main plate in titanium ceramic with 2 tablettes in matt marble ceramic

© Registered designs (INPI : 20200478 - 20205317)

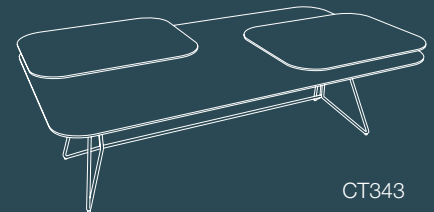

CT343

## COUCHTISCH

CT342 - CT343 / CT346

Hauptplatte und Drehplatten aus Keramik auf Glas 3 + 6 mm  
Ausführungen Gestell: Stahl schwarz matt lackiert

Abmessung geschlossen: 130 x 75 x H43 cm

Abmessung geöffnet: **CT342**: 161 x 75 x H43 cm

**CT343/346**: 193 x 75 x H43 cm

Nettogewicht: 39 kg

**CT342SD**: Hautplatte aus Keramik rostbraun und eine Drehplatte Keramik zementgrau

**CT342TI**: Hautplatte aus Keramik Titan und eine Drehplatte Keramik Marmoroptik matt

**CT342SI**: Hautplatte aus Keramik Silber und eine Drehplatte Keramik Titan

**CT343/346SD**: Hautplatte aus Keramik rostbraun und zwei Drehplatte Keramik zementgrau

**CT343/346TI**: Hautplatte aus Keramik Titan und zwei Drehplatte Keramik Marmoroptik matt

© Registrierte Modelle (INPI : 20200478 - 20205317)

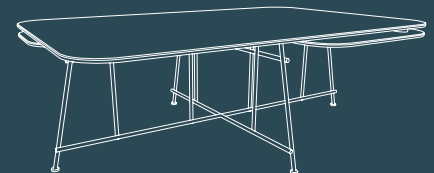

CT343

  
AKANTE®

TABLES DE REPAS  
DINING TABLES  
ESSTISCHE



**TABLES DE REPAS**  
*DINNING TABLES*  
**ESSTISCHE**

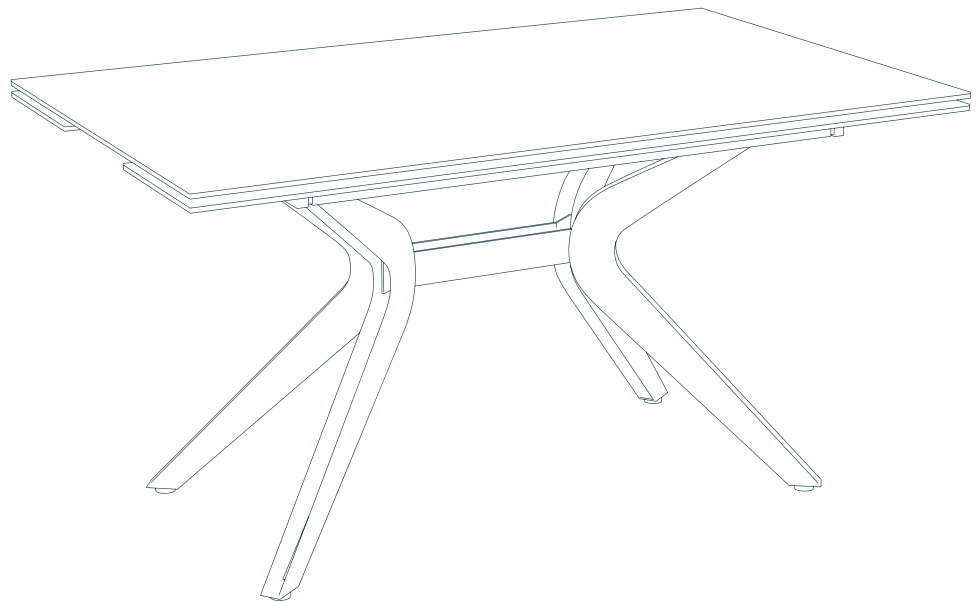

[www.akante.com](http://www.akante.com)

# AKANTE®

ASCENSION®





# ASCENSION<sup>®</sup>

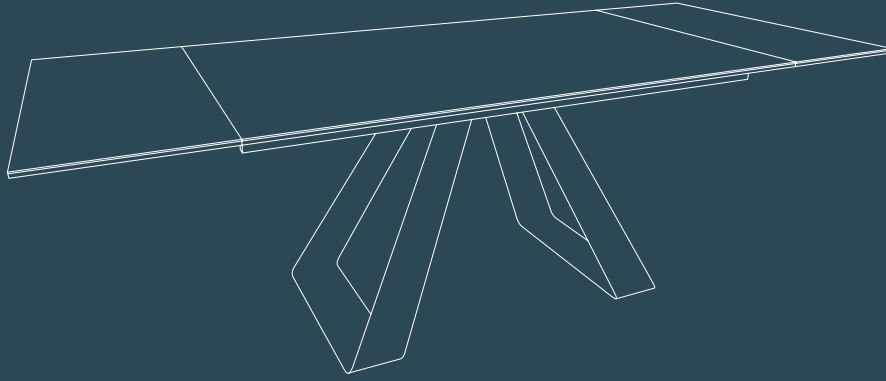

## TABLE DE REPAS

Plateau : Céramique sur verre épaisseur 3 + 8 mm  
2 rallonges rétractables indépendantes  
Piètement : acier laqué noir mat

AR / MA / SD / TI / SI / CC :

Plateau en céramique argile / marbre mat / acier / titane / silver / chêne clair

DT100 : Dimensions : 190/270 x 100 x h76 cm

Poids Net : 159 kg

DT105 : Dimensions : 150/230 x 100 x h76 cm

Poids Net : 166 kg

© Modèle déposé (Réf. INPI : 20205317)

## DINING TABLE

Plate : Ceramic on glass 3 + 8 mm thick  
2 independent retractable extensions  
Legs : black matt lacquered steel

AR / MA / SD / TI / SI / CC :

Plate in argile ceramic / matt marbled / steel / titanium / silver / clear oak

DT100 : Dimensions : 190/270 x 100 x H76 cm

Net Weight : 159 kgs

DT105 : Dimensions : 150/230 x 100 x H76 cm

Net Weight : 166 kgs

© Registered design (INPI : 20205317)

## ESSTISCH

Tischplatte: Keramik auf Glas 3 + 8 mm  
mit 2 voneinander unabhängigen Auszügen  
Gestell: Stahl schwarz matt lackiert

AR / MA / SD / TI / SI / CC:

Keramikplatte in zementgrau / Marmoroptik matt / rostbraun / Titan / silver / Eiche hell

DT100: Abmessung: 190/270 x 100 x H76 cm

Nettogewicht: 159 kg

DT105: Abmessung: 150/230 x 100 x H76 cm

Nettogewicht: 166 kg

© Registriertes Modell (INPI: 20205317)

# AKANTE®

AUGUSTE®



# AUGUSTE<sup>®</sup>

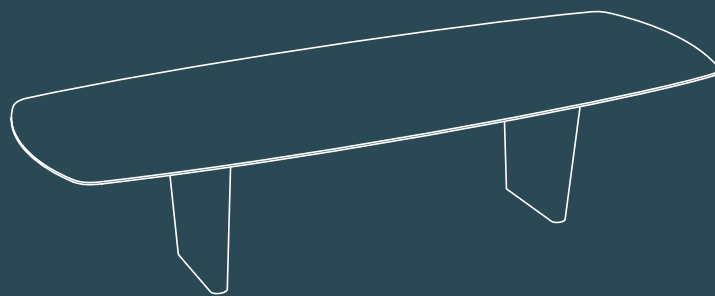

## TABLE DE REPAS

Plateau : Céramique de 6 mm collée sur un verre de 8 mm d'épaisseur, couleurs : Marbre Doro (MD), Marbre Fiorentino (MR), Marbre Calcatta (MC)

Piètement : Acier laqué noir mat

DT802 : Dimensions : 240 x 120 x h76 cm	Poids Net : 125 kg
DT806 : Dimensions : 260 x 120 x h76 cm	Poids Net : 133 kg
DT810 : Dimensions : 280 x 120 x h76 cm	Poids Net : 147 kg
DT814 : Dimensions : 300 x 120 x h76 cm	Poids Net : 164 kg
DT818 : Dimensions : 320 x 130 x h76 cm	Poids Net : 181 kg

© Modèle déposé (Réf. INPI : 20234015)

## DINING TABLE

Top : Ceramic over glass thickness 6 + 8 mm, colours : Doro marble (MD), Fiorentino marble (MR), Calcatta marble (MC)

Legs : Black lacquered steel

DT802 : Dimensions : 240 x 120 x h76 cm	Net Weight : 125 kgs
DT806 : Dimensions : 260 x 120 x h76 cm	Net Weight : 133 kgs
DT810 : Dimensions : 280 x 120 x h76 cm	Net Weight : 147 kgs
DT814 : Dimensions : 300 x 120 x h76 cm	Net Weight : 164 kgs
DT818 : Dimensions : 320 x 130 x h76 cm	Net Weight : 181 kgs

© Registered design (INPI : 20234015)

## ESSTISCH

Keramik auf Glas Stärke 6 + 8 mm, farben: Marmoroptik Doro (MD), Marmoroptik Fiorentino (MR), Marmoroptik Calcatta (MC)

Gestell: Stahl schwarz matt lackiert

DT802: Abmessung: 240 x 120 x H76 cm	Nettogewicht: 125 kg
DT806: Abmessung: 260 x 120 x H76 cm	Nettogewicht: 133 kg
DT810: Abmessung: 280 x 120 x H76 cm	Nettogewicht: 147 kg
DT814: Abmessung: 300 x 120 x H76 cm	Nettogewicht: 164 kg
DT818: Abmessung: 320 x 130 x H76 cm	Nettogewicht: 181 kg

© Registriertes Modell (INPI: 20234015)

# AKANTE®

AUSTIN - ICONE - SEATTLE®



DT188SD



DT188MM



DT180TI



DT180SI



DT118MC



DT136AR



DT186MA



DT186CC



# AUSTIN - ICONE - SEATTLE<sup>®</sup>

## TABLE DE REPAS

Plateau : Céramique de 3 mm collée sur un verre de 8 mm d'épaisseur, couleurs : Argile (AR), Marbre Mat (MA), Acier (SD), Silver (SI), Titane (TI) Chêne Clair (CC)  
Céramique de 6 mm collée sur un verre de 6 mm d'épaisseur, couleurs : marbre Marquina (MM), marbre Calacatta (MC)

2 rallonges rétractables synchronisées  
Piétements : Acier laqué noir mat

DT118 / DT180 / DT188

Dimensions : 90/135 x 135 x h76 cm  
Poids Net : DT118 : 87.8 kg / DT180 : 80.3 kg / DT188 : 96.5 kg

DT136 / DT186 / DT196

Dimensions : 90/150 x 150 x h76 cm  
Poids Net : DT136 : 98.3 kg / DT186 : 90.8 kg / DT196 : 107 kg

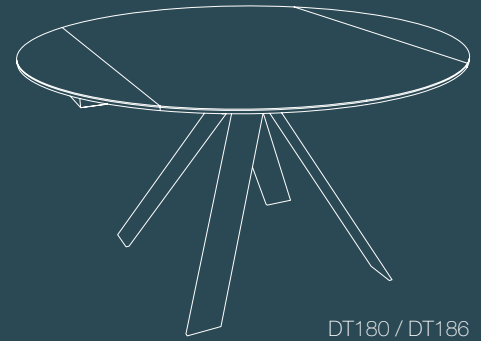

© Modèles déposés (Réf. INPI : 20222320)  
Modèles brevetés (Réf. INPI : FR1870192)

## DINING TABLE

Top plate : Ceramic over glass thickness 3 + 8 mm, colours : Argile (AR), Matt marble (MA), Steel dark (SD), Silver (SI), Titanium (TI), Clear oak (CC)  
Ceramic over glass thickness 6 + 6 mm, colours : Marquina marble (MM), Calacatta marble (MC)

2 pull-out extensions synchronized  
Legs : matt black lacquered steel

DT118 / DT180 / DT188

Dimensions : 90/135 x 135 x H76 cm  
Net weight : DT118 : 87.8 kgs / DT180 : 80.3 kgs / DT188 : 96.5 kgs

DT136 / DT186 / DT196

Dimensions : 90/150 x 150 x H76 cm  
Net weight : DT136 : 98.3 kgs / DT186 : 90.8 kgs / DT196 : 107 kgs

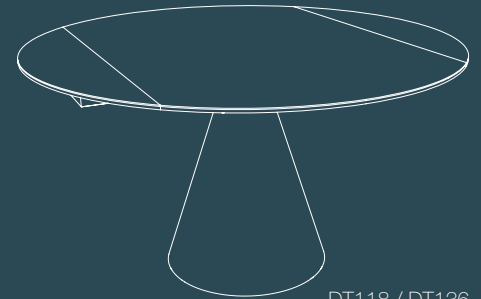

© Registered design (Réf INPI :  
20222320 - 20231433)  
Patented model (Réf. INPI FR1870192)

## ESSTISCH

Tischplatte: Keramik auf Glas Stärke 3 + 8 mm, farben: zementgrau (AR), Marmoroptik matt (MA), rostbraun (SD), silver (SI), Titan (TI), eiche hell (CC)  
Keramik auf Glas Stärke 6 + 6 mm, farben: Marmoroptik Marquina (MM), Marmoroptik Calacatta (MC)

Mit 2 synchronisierte einziehbaren Verlängerungen  
Gestell: Stahl gebürstet

DT118 / DT180 / DT188

Abmessung: 90/135 x 135 x H76 cm  
Nettogewicht: DT118: 87.8 kg / DT180: 80.3 kg / DT188: 96.5 kg

DT136 / DT186 / DT196

Abmessung: 90/150 x 150 x H76 cm  
Nettogewicht: DT136: 98.3 kg / DT186: 90.8 kg / DT196: 107 kg

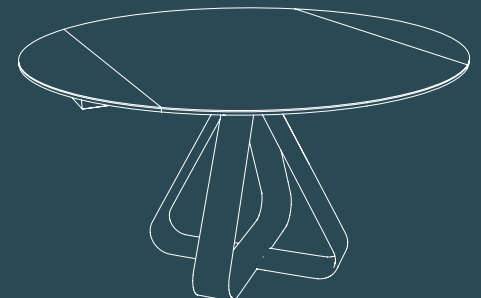

© Registriertes Modell (INPI 20222320)  
Patentiertes Modell (INPI FR1870192)

# AKANTE®

BABYLONE®



# BABYLONE<sup>®</sup>

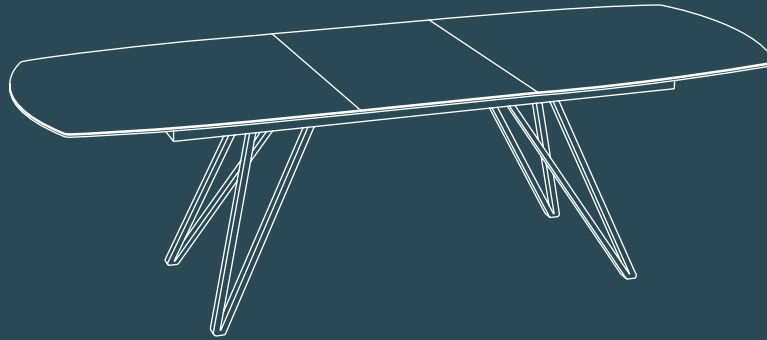

## TABLE DE REPAS

Plateau en céramique de 3 mm collé sur un verre de 8 mm d'épaisseur, couleurs : Argile (AR), Marbre Mat (MA), Acier (SD), Silver (SI), Titane (TI), Chêne Clair (CC)

Une rallonge centrale rétractable

Piètement : Acier laqué noir mat (équipé de patins réglables)

DT074 : Dimensions : 160/200 x 100 x h76 cm Poids Net : 97 kg

DT075 : Dimensions : 200/260 x 100 x h76 cm Poids Net : 111 kg

© Modèle déposé (Réf. INPI : 20231433)

## DINING TABLE

Top plate : Ceramic over glass thickness 3 + 8 mm, colours : Argile (AR), Matt marble (MA), Steel dark (SD), Silver (SI), Titanium (TI), Clear oak (CC)

One pull-out central extension

Legs : Black lacquered steel (with built-in levellers)

DT074 : Dimensions : 160/200 x 100 x h76 cm Net Weight : 97 kgs

DT075 : Dimensions : 200/260 x 100 x h76 cm Net Weight : 111 kgs

© Registered design (INPI : 20231433)

## ESSTISCH

Tischplatte: 3 mm Keramik, geklebt auf 8mm Glas, farben: zementgrau (AR), Marmoroptik matt (MA), rostbraun (SD), silver (SI), Titan (TI), eiche hell (CC)

2 synchronisierte einziehbare Verlängerungen

Gestell: Stahl schwarz lackiert (mit plastikcappe)

DT074: Abmessung: 160/200 x 100 x H76 cm Nettogewicht: 97 kg

DT075: Abmessung: 200/260 x 100 x H76 cm Nettogewicht: 111 kg

© Registriertes Modell (INPI: 20231433)

# AKANTE®

BELLAGIO®





# BELLAGIO<sup>®</sup>

## TABLE DE REPAS

DT078/DT079

🇫🇷 Plateau : HA / SD / AR / MA / SI / TI / CC : Céramique sur verre épaisseur : 3 + 8 mm  
MM / MC / MD / MR : Céramique sur verre épaisseur : 6 + 6 mm  
2 rallonges rétractables synchronisées  
Piétement : Acier laqué noir (équipé de patins réglables)

DT079HA / SD / AR / MA / SI / TI / CC :  
Plateau céramique havane / acier / argile / marbre mat /  
silver / titane / chêne clair  
DT079MM / MC / MD / MR :  
Plateau céramique Marbre Marquina / Marbre Calcatta /  
Marbre Doro / Marbre Fiorentino

Dimensions : DT079 : 130/190 x 100 x h76 cm  
DT078 : 120/180 x 90 x h76 cm

Poids Net : 105 kg  
Poids Net : 117.2 kg

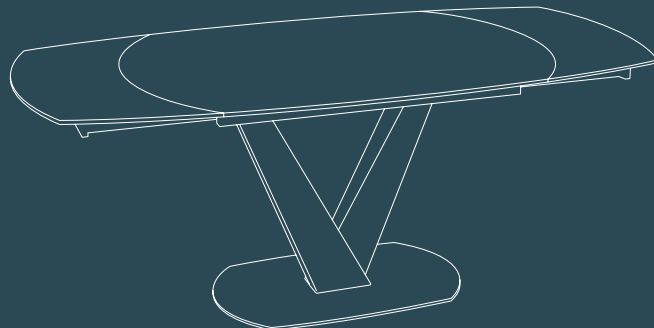

© Modèle déposé (Réf. INPI : 20215513)

## 🇬🇧 DINING TABLE

DT078/DT079

Top : HA / SD / AR / MA / SI / TI / CC : Ceramic over glass 3 + 8 mm  
MM / MC / MD / MR : Ceramic over glass 6 + 6 mm  
Two synchronised pull-out extensions  
Legs : Black lacquered steel (with built-in levellers)

DT079HA / SD / AR / MA / SI / TI / CC :  
Tops in ceramic havana / steel dark / argile / matt marble / silver / titanium / light oak  
DT079MM / MC / MD / MR :  
Tops in ceramic Marble Marquina / Marble Calcatta / Marble Doro / Marble Fiorentino

Dimensions : DT079 : 130/190 x 100 x h76 cm  
DT078 : 120/180 x 90 x h76 cm

Net Weight : 105 kgs  
Net Weight : 117.2 kgs

© Registered design (INPI : 20215513)

## 🇩🇪 ESSTISCH

DT078/DT079

Platte: HA / SD / AR / MA / SI / TI / CC: 3 mm Keramikplatte auf 8 mm starkem Glas  
MM / MC / MD / MR: 6 mm Keramikplatte auf 6 mm starkem Glas  
mit 2 einziehbaren, synchronisierten Auszügen  
Gestell: Stahl schwarz lackiert (mit plastikklappe)

DT079HA / SD / AR / MA / SI / TI / CC:  
Ausführungen der Keramikplatte: Havanna / rostbraun / zementgrau / Marmoroptik matt / silver /  
Titan / Eiche hell  
DT079MM / MC / MD / MR:  
Ausführungen der Keramikplatte: Marmoroptik Marquina / Marmoroptik Calcatta / Marmoroptik Doro /  
Marmoroptik Fiorentino

Abmessung: DT079: 130/190 x 100 x H76 cm  
DT078: 120/180 x 90 x H76 cm

Nettogewicht: 105 kg  
Nettogewicht: 117.2 kg

# AKANTE®

BOGOTA®

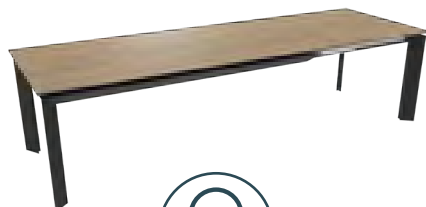

# BOGOTA<sup>®</sup>

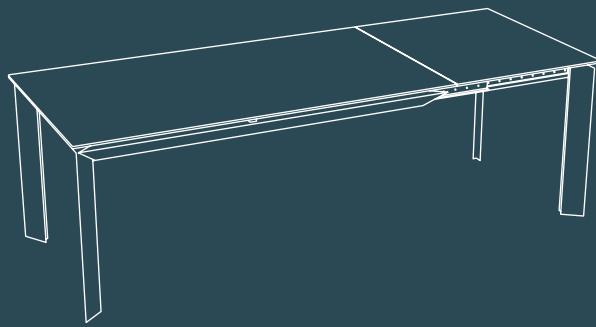

## TABLE DE REPAS

DT650 / DT652

Plateau en céramique de 3 mm collé sur un verre de 8 mm d'épaisseur, couleurs : Argile (AR), Marbre Mat (MA), Acier (SD), Silver (SI), Titane (TI), Chêne Clair (CC)

1 rallonge latérale coulissante

Piètement : Acier laqué noir mat (équipé de patins réglables)

DT650 : Dimensions fermées : 180 x 100 x h76 cm  
Dimensions ouvertes : 260 x 100 x h76 cm

Poids Net : 115 kg

DT652 : Dimensions fermées : 200 x 100 x h76 cm  
Dimensions ouvertes : 300 x 100 x h76 cm

Poids Net : 140 kg

© Modèle déposé (Réf. INPI : 20234015)



## DINING TABLE

DT650 / DT652

Top plate : Ceramic over glass thickness 3 + 8 mm, colours : Argile (AR), Matt marble (MA), Steel dark (SD), Silver (SI), Titanium (TI), Clear oak (CC)

1 sliding side extension

Black lacquered steel (with built-in levellers)

DT650 : Dimensions closed : 180 x 100 x h76 cm  
Dimensions opened : 260 x 100 x h76 cm

Net Weight : 115 kgs

DT652 : Dimensions closed : 200 x 100 x h76 cm  
Dimensions opened : 300 x 100 x h76 cm

Net Weight : 140 kgs

© Registered design (INPI : 20234015)



## ESSTISCH

DT650 / DT652

Tischplatte: Keramik auf Glas Stärke 3 + 8 mm, farben: zementgrau (AR), Marmoroptik matt (MA), rostbraun (SD), silver (SI), Titan (TI), eiche hell (CC)

1 verschiebbare Seitenverlängerung

Gestell: Stahl schwarz matt lackiert (mit plastikcappe)

DT650: Abmessung: 180 x 100 x H76 cm  
Abmessung geöffnet: 260 x 100 x H76 cm

Nettogewicht: 115 kg

DT652: Abmessung: 200 x 100 x H76 cm  
Abmessung geöffnet: 300 x 100 x H76 cm

Nettogewicht: 140 kg

© Registriertes Modell (INPI : 20234015)

# AKANTE®

CALIFORNIA ©



DT072AR



DT072CC



DT072MA



DT073SD



DT073SI



DT073TI



# CALIFORNIA<sup>®</sup>

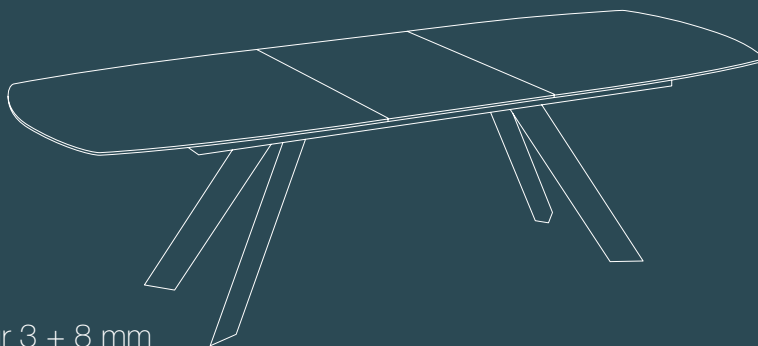

## TABLE DE REPAS

Plateau : Céramique sur verre épaisseur 3 + 8 mm  
Piétement : Acier laqué noir mat (équipé de patins réglables)  
Une rallonge centrale rétractable

### DT072TI / SI / SD / AR / MA / CC :

Plateau céramique titane / silver / acier / argile / marbre mat / chêne clair  
Dimensions : 160/200 x 100 x h76 cm - Poids : 94,5 kg

### DT073TI / SI / SD / AR / MA / CC :

Plateau céramique titane / silver / acier / argile / marbre mat / chêne clair  
Dimensions : 200/260 x 100 x h76 cm - Poids : 108,5 kg

© Modèle déposé à l'INPI

## DINING TABLE

Top : Ceramic over glass thickness 3 + 8 mm  
Legs : Black lacquered steel mat (with built-in levellers)  
One pull-out central extension

### DT072TI / SI / SD / AR / MA / CC :

Tops in ceramic titanium / silver / steel dark / argile / matt marble / clear oak  
Dimensions : 160/200 x 100 x H76 cm - Net Weight : 94,5 kgs

### DT073TI / SI / SD / AR / MA / CC :

Tops in ceramic titanium / silver / steel dark / argile / matt marble / clear oak  
Dimensions : 200/260 x 100 x H76 cm - Net Weight : 108,5 kgs

© Registered design INPI

## ESSTISCH

Tischplatte: Keramik auf Glas Dicke 3 + 8 mm  
Gestell: Stahl schwarz lackiert (mit plastikkappe)  
Mit zentraler Verlängerungsplatte

### DT072TI / SI / SD / AR / MA / CC:

Obere Platte aus Keramik Titan / silver / rostbraun / zementgrau / Marmoroptik matt / Eiche hell  
Abmessung: 160/200 x 100 x H76 cm - Nettogewicht: 94,5 kg

### DT073TI / SI / SD / AR / MA / CC:

Obere Platte aus Keramik Titan / silver / rostbraun / zementgrau / Marmoroptik matt / Eiche hell  
Abmessung: 200/260 x 100 x H76 cm - Nettogewicht: 108,5 kg

© Registriertes Modell INPI

# AKANTE®

## CHANTERELLE®



# CHANTERELLE<sup>®</sup>



## TABLE DE REPAS

Plateaux périphériques en céramique collés sur verre 3 + 8 mm  
2 Rallonges centrales en céramique de 3 mm collée sur MDF  
Piètement : Acier laqué noir mat (équipé de patins réglables)

### DT132AR / MA / SD / SI / TI / CC :

Plateau supérieur en céramique argile / marbre mat / acier / silver / titane / chêne clair  
Dimensions : 110/145 x 110 x h76 cm  
Poids Net : 107 kg

### DT130AR / MA / SD / SI / TI / CC :

Plateau supérieur en céramique argile / marbre mat / acier / silver / titane / chêne clair  
Dimensions : 130/180 x 130 x h76 cm  
Poids Net : 120 kg

© Modèle déposé (Réf. INPI : 20205317)

## DINING TABLE

Plate : ceramic on glass 3 + 8 mm thick  
2 central extensions in ceramic 3 mm on MDF  
Legs : Black matt lacquered steel (with built-in levellers)

### DT132AR / MA / SD / SI / TI / CC :

Upper plate in argile ceramic / matt marble / steel / silver / titanium / clear oak  
Dimensions : 110/145 x 110 x H76 cm  
Net Weight : 107 kgs

### DT130AR / MA / SD / SI / TI / CC :

Upper plate in argile ceramic / matt marble / steel / silver / titanium / clear oak  
Dimensions : 130/180 x 130 x H76 cm  
Net Weight : 120 kgs

© Registered design (INPI : 20205317)

## ESSTISCH

Tischplatte: Keramik auf Glas, Stärke 3 + 8 mm  
Zwei mittlere auszugsplatten  
Gestell: Stahl schwarz matt lackiert (mit plastikplatte)

### DT130AR / MA / SD / SI / TI / CC:

Keramikplatte zementgrau / Marmoroptik matt / rostbraun / silver / Titan / eiche hell  
Abmessung: 110/145 x 110 x H76 cm  
Nettogewicht: 107 kg

### DT130AR / MA / SD / SI / TI / CC:

Keramikplatte zementgrau / Marmoroptik matt / rostbraun / silver / Titan / eiche hell  
Abmessung: 130/180 x 130 x H76 cm  
Nettogewicht: 120 kg

© Registriertes Modell (INPI : 20205317)

# AKANTE®

COLUMBIA®





# COLUMBIA<sup>®</sup>

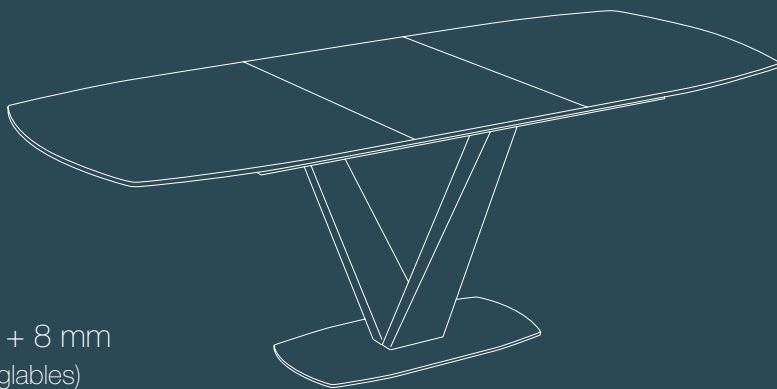

## TABLE DE REPAS

Plateau : Céramique sur verre épaisseur 3 + 8 mm  
Piétement : Acier laqué noir (équipé de patins réglables)  
Une rallonge centrale rétractable

DT065 : Dimensions : 160/200 x 100 x h76 cm

DT067 : Dimensions : 200/260 x 100 x h76 cm

Poids Net : 109 kg

Poids Net : 119 kg

DT065/67 TI / SD / AR / MA / SI / CC :

Plateau céramique titane / acier / argile / marbre mat / silver / chêne clair

© Modèle déposé à l'INPI (Réf. INPI : 20215513)

## DINING TABLE

Top : Ceramic over glass thickness 3 + 8 mm  
Legs : Black lacquered steel (with built-in levellers)  
One pull-out central extension

DT065 : Dimensions : 160/200 x 100 x H76 cm

DT067 : Dimensions : 200/260 x 100 x H76 cm

Net Weight : 109 kgs

Net Weight : 119 kgs

DT065/67 TI / SD / AR / MA / SI / CC :

Tops in ceramic titanium / steel dark / argile / matt marble / silver / light oak

© Registered design (INPI : 20215513)

## ESSTISCH

Tischplatte: Keramik auf Glas Dicke 3 + 8 mm  
Gestell: Stahl schwarz lackiert (mit plastikplatte)  
Mit zentraler Verlängerungsplatte

DT065: Abmessung: 160/200 x 100 x H76 cm

DT067: Abmessung: 200/260 x 100 x H76 cm

Nettogewicht: 109 kg

Nettogewicht: 119 kg

DT065/67 TI / SD / AR / MA / SI / CC:

Ausführungen der Keramikplatte: Titan / rostbraun / zementgrau / Marmoroptik matt / silver / Eiche hell

© Registriertes Modell (INPI : 20215513)

# AKANTE®

CONNEXION®



# CONNEXION<sup>®</sup>

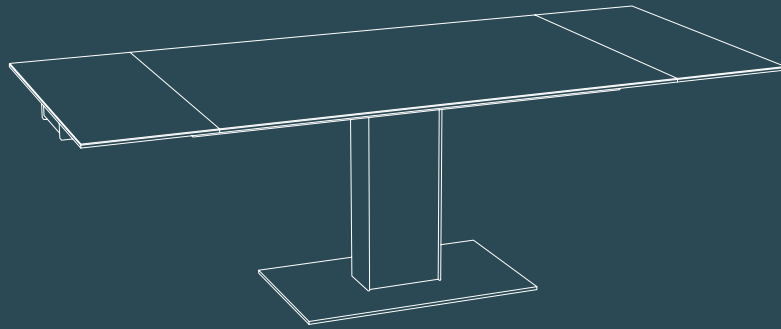

## TABLE DE REPAS

Plateau : Céramique sur verre épaisseur 3 + 8 mm - 2 rallonges indépendantes rétractables  
Piétement : Acier laqué noir mat (équipé de patins réglables)

Dimensions : 150/230 x 100 x h76 cm                      Poids Net : 119 kg

DT110SI / TI / SD / MA / AR / CC :  
Plateau céramique silver / titane / acier / marbre mat / argile / chêne clair

© Modèles déposés (Réf. INPI : 20215513)

## DINING TABLE

Top : Ceramic over glass 3 + 8 mm - Two independant pull-out extensions  
Legs : Matt black lacquered steel (with built-in levellers)

Dimensions : 150/230 x 100 x H76 cm                      Net Weight : 119 kgs

DT110SI / TI / SD / MA / AR / CC :  
Tops in ceramic silver / titanium / steel dark / matt marble / argile / light oak

© Registered design (INPI : 20215513)



## ESSTISCH

3 mm Keramikplatte auf 8 mm starkem Glas mit 2 voneinander unabhängigen Auszügen  
Gestell: Stahl schwarz matt lackiert (mit plastikkappe)

Abmessung: 150/230 x 100 x H76 cm                      Nettogewicht: 119 kg

DT110SI / TI / SD / MA / AR / CC:  
Ausführungen der Keramikplatte: silver / Titan / rostbraun / Marmoroptik matt / zementgrau / Eiche hell

© Registriertes Modell (INPI 20215513)

# AKANTE®

FASCINATION - PAPYRUS ©



# FASCINATION - PAPYRUS®

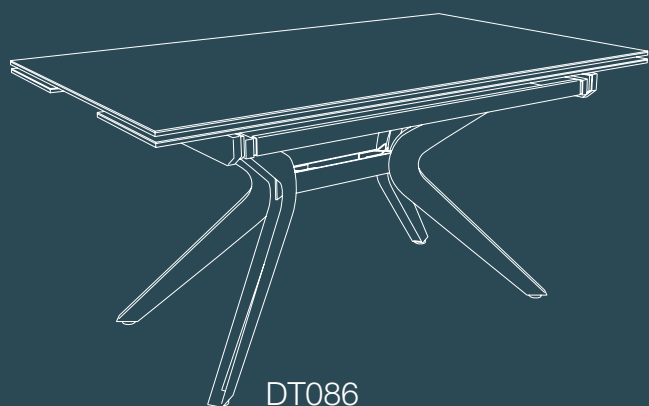

DT086

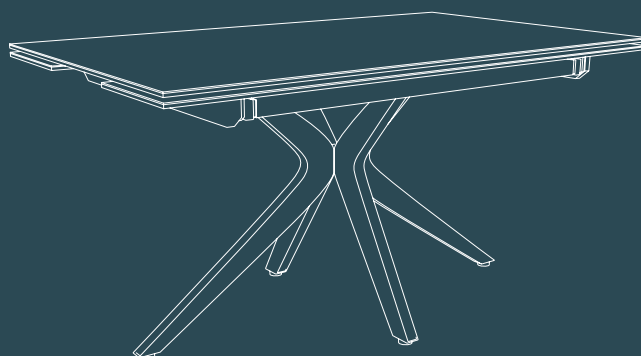

DT087

## TABLE DE REPAS DT086 / DT087

Plateau : céramique sur verre épaisseur : 3 + 8 mm ou céramique pleine masse de 11 mm  
2 rallonges rétractables indépendantes (piètement équipé de patins réglables)  
Dimensions : 150/90 x 150 x h76 cm  
Poids Net : 96 kg

Céramiques AR / SI / SD / TI / MA / CC / MC / MM :

Plateau céramique argile / silver / acier / titane / marbre mat / chêne clair / Marbre Calcatta / Marbre Marquina

© Modèle déposé (Réf. INPI : 20200478)

## DINING TABLE DT086 / DT087

Top : ceramic over glass 3 + 8 mm or full body ceramic thickness 11 mm  
Two independant pull-out extensions (legs with built-in levellers)  
Dimensions : 150/90 x 150 x H76 cm  
Net Weight : 96 kgs

Ceramics AR / SI / SD / TI / MA / CC / MC / MM :

Top in ceramic argile / silver / steel dark / titanium / matt marble / clear oak / Calcatta marble / Marquina marble

© Registered design (INPI : 20200478)

## ESSTISCH DT086 / DT087

3 mm Keramikplatte auf 8 mm starkem Glas oder 11 mm dicke Vollkeramik  
2 voneinander unabhängig einziehbare Verlängerungen (Gestell mit plastikappe)  
Abmessung: 150/90 x 150 x H76 cm  
Nettogewicht: 96 kg

Keramik AR / SI / SD / TI / MA / CC / MC / MM:

Obere Platte aus Keramik Titan / silver / rostbraun / zementgrau / Marmoroptik matt / Eiche hell / Marmoroptik Calcatta / Marmoroptik Marquina

© Registriertes Modell (INPI : 20200478)

# AKANTE

FLORA



# FLORA

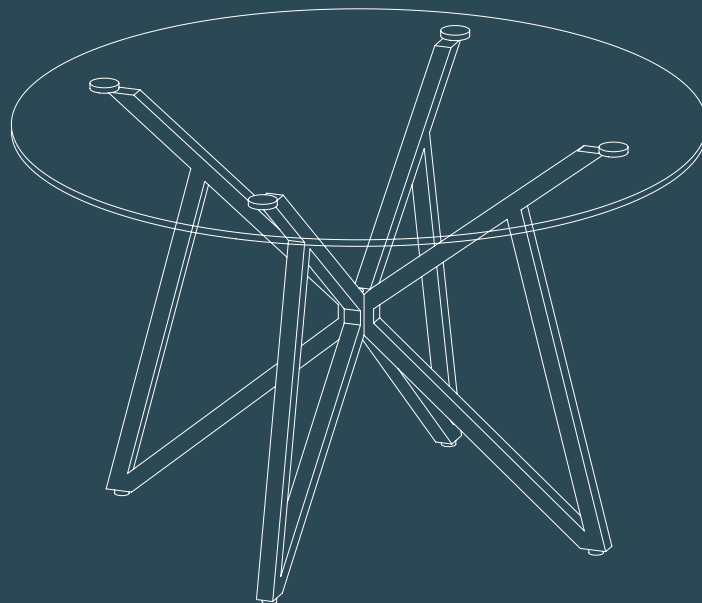

 TABLE DE REPAS

DT014C

Plateau : Verre clair trempé avec une épaisseur de 12 mm  
Piétement : Acier inoxydable poli

Dimensions : Ø120 x 75 cm  
Poids Net : 34.1 kg

 DINING TABLE

DT014C

Top : 12 mm clear tempered glass  
Legs : polished stainless steel

Dimensions : Ø120 x 75 cm  
Net Weight : 34.1 kgs

 TABLE DE REPAS

DT014C

Tischplatte: klares Temperglas, Stärke 12 mm  
Gestell: Edelstahl glanzpoliert

Abmessung: Ø120 x 75 cm  
Nettogewicht: 34.1 kg

# AKANTE®

GOLIATH®





# GOLIATH<sup>®</sup>

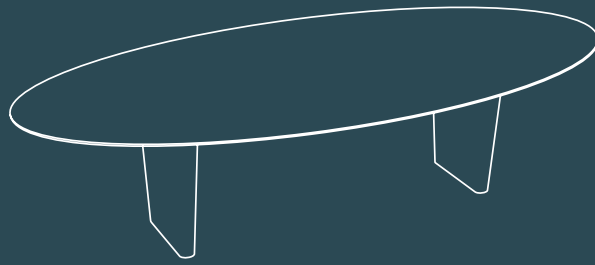

## TABLE DE REPAS

Plateau : Céramique de 6 mm collée sur un verre de 8 mm d'épaisseur, couleurs : Marbre Doro (MD), Marbre Fiorentino (MR), Marbre Calcatta (MC)

Piètement : Acier laqué noir mat

DT804 : Dimensions : 240 x 112 x h76 cm	Poids Net : 119 kg
DT808 : Dimensions : 260 x 120 x h76 cm	Poids Net : 132 kg
DT812 : Dimensions : 280 x 130 x h76 cm	Poids Net : 147 kg
DT816 : Dimensions : 300 x 140 x h76 cm	Poids Net : 164 kg
DT820 : Dimensions : 320 x 150 x h76 cm	Poids Net : 181 kg

© Modèle déposé (Réf. INPI : 20231433)

## DINING TABLE

Top : Ceramic over glass thickness 6 + 8 mm, colours : Doro marble (MD), Fiorentino marble (MR), Calcatta marble (MC)

Legs : Black lacquered steel

DT804 : Dimensions : 240 x 112 x h76 cm	Net Weight : 119 kgs
DT808 : Dimensions : 260 x 120 x h76 cm	Net Weight : 132 kgs
DT812 : Dimensions : 280 x 130 x h76 cm	Net Weight : 147 kgs
DT816 : Dimensions : 300 x 140 x h76 cm	Net Weight : 164 kgs
DT820 : Dimensions : 320 x 150 x h76 cm	Net Weight : 181 kgs

© Registered desisgn (INPI : 20231433)

## ESSTISCH

Keramik auf Glas Stärke 6 + 8 mm, farben: Marmoroptik Doro (MD), Marmoroptik Fiorentino (MR), Marmoroptik Calcatta (MC)

Gestell: Stahl schwarz matt lackiert

DT804: Abmessung: 240 x 112 x H76 cm	Nettogewicht: 119 kg
DT808: Abmessung: 260 x 120 x H76 cm	Nettogewicht: 132 kg
DT812: Abmessung: 280 x 130 x H76 cm	Nettogewicht: 147 kg
DT816: Abmessung: 300 x 140 x H76 cm	Nettogewicht: 164 kg
DT820: Abmessung: 320 x 150 x H76 cm	Nettogewicht: 181 kg

© Registriertes Modell (INPI : 20231433)

# AKANTE®

HÉLION®



# HÉLION<sup>®</sup>

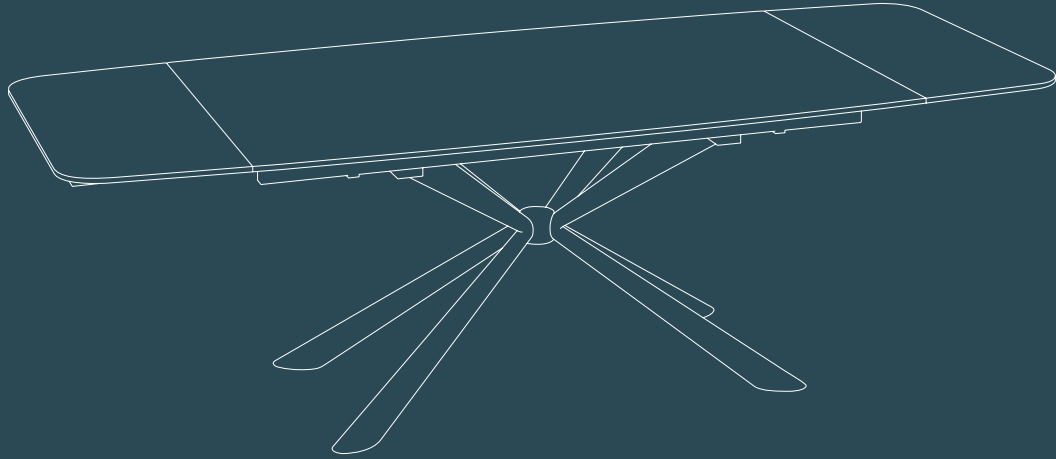

TABLE DE REPAS

DT098/DT198

Plateau : Céramique sur verre épaisseur : 3 + 8 mm - 2 rallonges rétractables

Piètement : Acier laqué noir mat (équipé de patins réglables)

AR / CC / MA / SD / SI / TI : Plateau céramique argile / chêne clair / marbre mat / acier / silver / titane

DT098 : Dimensions : 160/240 x 100 x h76 cm - Poids Net : 89 kg

DT198 : Dimensions : 190/270 x 100 x h76 cm - Poids Net : 101 kg

© Modèle déposé (Réf. INPI : 20222320)



DINING TABLE

DT098/DT198

Top : Ceramic over glass 3 + 8 mm - Two pull-out extensions

Legs : Matt black lacquered steel (with built-in levellers)

AR / CC / MA / SD / SI / TI : Argile ceramic top / clear oak / Matt marble / Steel / Silver / Titanium

DT098 : Dimensions : 160/240 x 100 x H76 cm - Net Weight : 89 kgs

DT198 : Dimensions : 190/240 x 100 x H76 cm - Net Weight : 101 kgs

© Registered design (INPI : 20222320)



ESSTISCH

DT098/DT198

3 mm Keramikplatte auf 8 mm starkem Glas - 2 einziehbare Verlängerungen

Gestell: Stahl schwarz lackiert (mit plastikkappe)

AR / CC / MA / SD / SI / TI: Keramikplatte zementgrau / Eiche hell / Marmoroptik matt / rostbraun / silver / Titan

DT098: Abmessung: 160/240 x 100 x H76 cm - Nettogewicht: 89 kg

DT198: Abmessung: 190/270 x 100 x H76 cm - Nettogewicht: 101 kg

© Registriertes Modell (INPI : 20222320)

# AKANTE®

HOUSTON®



DT115AR



DT115MA



DT115SD



DT120CC



DT120SI



DT120TI



# HOUSTON<sup>®</sup>

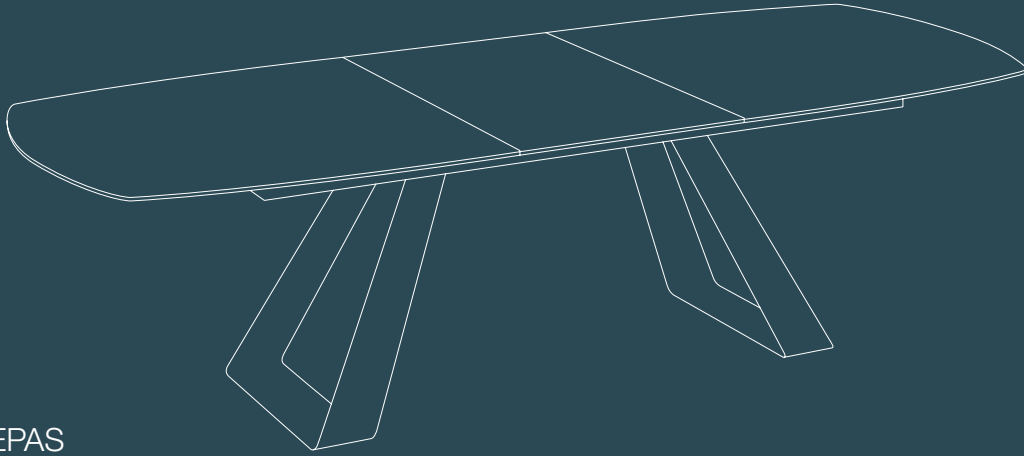

## TABLE DE REPAS

Plateau : Céramique sur verre épaisseur 3 + 8 mm - 1 rallonge centrale rétractable  
Piétement : Acier laqué noir mat

### DT115TI / SI / SD / AR / MA / CC :

Plateau céramique titane / silver / acier / argile / marbre mat / chêne clair  
Dimensions : 160/200 x 100 x h76 cm - Poids : 147 kg

### DT120TI / SI / SD / AR / MA / CC :

Plateau céramique titane / silver / acier / argile / marbre mat / chêne clair  
Dimensions : 200/260 x 100 x h76 cm - Poids : 161 kg

© Modèle déposé (Réf. INPI : 20231433)

## DINING TABLE

Top : Ceramic over glass thickness 3 + 8 mm - One pull-out central extension  
Legs : Black lacquered steel mat

### DT115TI / SI / SD / AR / MA / CC :

Tops in ceramic titanium / silver / steel dark / argile / matt marble / clear oak  
Dimenisons : 160/200 x 100 x H76 cm - Net Weight : 147 kgs

### DT120TI / SI / SD / AR / MA / CC :

Tops in ceramic titanium / silver / steel dark / argile / matt marble / clear oak  
Dimenisons : 200/260 x 100 x H76 cm - Net Weight : 161 kgs

© Registered design (INPI : 20231433)

## ESSTISCH

Tischplatte: Keramik auf Glas Dicke 3 + 8 mm - Mit zentraler Verlängerungsplatte  
Gestell: Edelstahl schwarz lackiert

### DT115TI / SI / SD / AR / MA / CC:

Obere Platte aus Keramik Titan / silver / rostbraun / zementgrau / Marmoroptik matt / Eiche hell  
Abmessung: 160/200 x 100 x H76 cm - Nettogewicht: 147 kg

### DT120TI / SI / SD / AR / MA / CC:

Obere Platte aus Keramik Titan / silver / rostbraun / zementgrau / Marmoroptik matt / Eiche hell  
Abmessung: 200/260 x 100 x H76 cm - Nettogewicht: 161 kg

© Registriertes Modell (INPI: 20231433)

# AKANTE®

IMPULSION®



# IMPULSION<sup>®</sup>

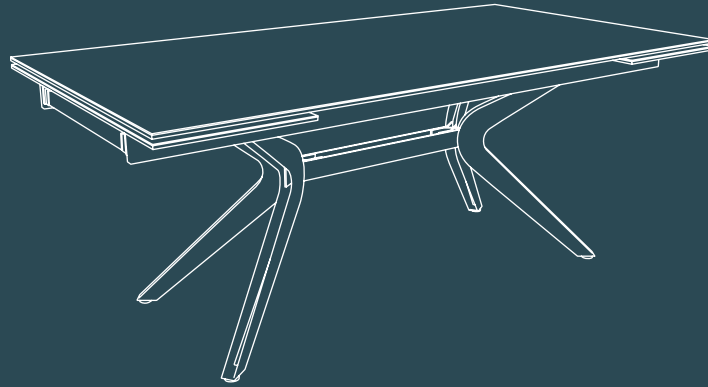

## TABLE DE REPAS

Plateau : Céramique sur verre épaisseur : 3 + 8 mm - 2 rallonges rétractables indépendantes  
Piétement équipé de patins réglables

DT084AR / MA : Plateau céramique argile / marbre mat

Piétement : acier laqué taupe - Dimensions : 190/270 x 100 x 76 cm - Poids : 116 kg

DT090AR / MA : Plateau céramique argile / marbre mat

Piétement : acier laqué taupe - Dimensions : 150/230 x 100 x 76 cm - Poids : 95 kg

DT094AR / MA / SD / SI / TI / CC : argile / marbre mat / acier / silver / titane / chêne clair

Piétement : acier laqué noir - Dimensions : 190/270 x 100 x 76 cm - Poids : 116 kg

DT095AR / MA / SD / SI / TI / CC : argile / marbre mat / acier / silver / titane / chêne clair

Piétement : acier laqué noir - Dimensions : 150/230 x 100 x 76 cm - Poids : 95 kg

© Modèle déposé (Réf. INPI : 20190743)

## DINING TABLE

Top : Ceramic over glass 3 + 8 mm - Two independant pull-out extensions  
Legs with built-in levellers

DT084AR / MA : argile / matt marble ceramic top

Legs : taupe lacquered steel - Dimensions : 190/270 x 100 x 76 cm - Net Weight : 116 kgs

DT090AR / MA : argile / matt marble ceramic top

Legs : taupe lacquered steel - Dimensions : 150/230 x 100 x 76 cm - Net Weight : 95 kgs

DT094AR / MA / SD / SI / TI / CC : argile / matt marble / steel dark / silver / titanium / light oak

Legs : black lacquered steel - Dimensions : 190/270 x 100 x 76 cm - Net Weight : 116 kgs

DT095AR / MA / SD / SI / TI / CC : argile / matt marble / steel dark / silver / titanium / light oak

Legs : black lacquered steel - Dimensions : 150/230 x 100 x 76 cm - Net Weight : 95 kgs

© Registered design (INPI : 20190743)

## ESSTISCH

3 mm Keramikplatte auf 8 mm starkem Glas - 2 voneinander unabhängig einziehbare Verlängerungen  
Gestell mit Plastikklappe

DT084AR / MA: Keramikplatte zementgrau / Marmoroptik matt

Gestell: Stahl taupe lackiert - Abmessung: 190/270 x 100 x 76 cm - Nettogewicht: 116 kg

DT090AR / MA: Keramikplatte zementgrau / Marmoroptik matt

Gestell: Stahl taupe lackiert - Abmessung: 150/230 x 100 x 76 cm - Nettogewicht: 95 kg

DT094AR / MA / SD / SI / TI / CC: zementgrau / Marmoroptik matt / rostbraun / silver / Titan / Eiche hell

Gestell: Stahl schwarz lackiert - Abmessung: 190/270 x 100 x 76 cm - Nettogewicht: 116 kg

DT095AR / MA / SD / SI / TI / CC: zementgrau / Marmoroptik matt / rostbraun / silver / Titan / Eiche hell

Gestell: Stahl schwarz lackiert - Abmessung: 150/230 x 100 x 76 cm - Nettogewicht: 95 kg

# AKANTE®

INFLUENCE®





# INFLUENCE<sup>®</sup>

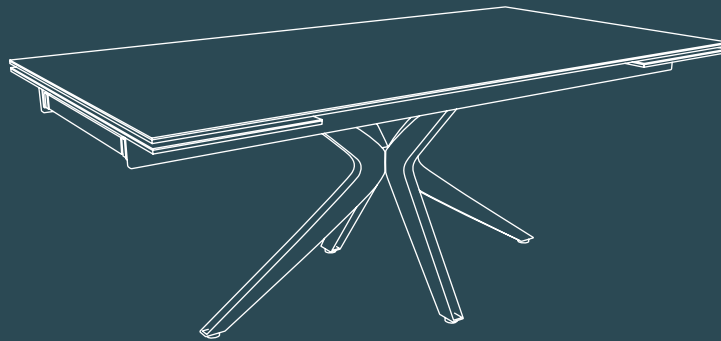

## TABLE DE REPAS

Plateau : Céramique sur verre épaisseur : 3 + 8 mm - 2 rallonges rétractables indépendantes  
Piétement équipé de patins réglables

DT082AR / MA : Plateau céramique argile / marbre mat

Piétement : acier laqué taupe - Dimensions : 190/270 x 100 x h76 cm - Poids : 141 kg

DT093AR / MA : Plateau céramique argile / marbre mat

Piétement : acier laqué taupe - Dimensions : 150/230 x 100 x h76 cm - Poids : 137 kg

DT092AR / MA / SD / SI / TI / CC : argile / marbre mat / acier / silver / titane / chêne clair

Piétement : acier laqué noir - Dimensions : 190/270 x 100 x h76 cm - Poids : 141 kg

DT097AR / MA / SD / SI / TI / CC : argile / marbre mat / acier / silver / titane / chêne clair

Piétement : acier laqué noir - Dimensions : 150/230 x 100 x h76 cm - Poids : 137 kg

© Modèle déposé (Réf. INPI : 20190743)

## DINING TABLE

Top : Ceramic over glass 3 + 8 mm - Two independant pull-out extensions  
Legs with built-in levellers

DT082AR / MA : argile / matt marble ceramic top

Legs : taupe lacquered steel - Dimensions : 190/270 x 100 x H76 cm - Net Weight : 141 kgs

DT093AR / MA : argile / matt marble ceramic top

Legs : taupe lacquered steel - Dimensions : 150/230 x 100 x H76 cm - Net Weight : 137 kgs

DT092AR / MA / SD / SI / TI / CC : argile / matt marble / steel dark / silver / titanium / clear oak

Legs : black lacquered steel - Dimensions : 190/270 x 100 x H76 cm - Net Weight : 141 kgs

DT097AR / MA / SD / SI / TI / CC : argile / matt marble / steel dark / silver / titanium / clear oak

Legs : black lacquered steel - Dimensions : 150/230 x 100 x H76 cm - Net Weight : 137 kgs

© Registered design (INPI : 20190743)

## ESSTISCH

3 mm Keramikplatte auf 8 mm starkem Glas - 2 voneinander unabhängig ausziehbare Verlängerungen  
Gestell mit plastikkappe

DT082AR / MA: keramikplatte zementgrau / Marmoroptik matt

Gestell: Stahl taupe lackiert - Abmessung: 190/270 x 100 x H76 cm - Nettogewicht: 141 kg

DT093AR / MA: keramikplatte zementgrau / Marmoroptik matt

Gestell: Stahl taupe lackiert - Abmessung: 150/230 x 100 x H76 cm - Nettogewicht: 137 kg

DT092AR/ MA / SD / SI / TI / CC: zementgrau / Marmoroptik matt / rostbraun / silver / Titan / Eiche hell

Gestell: Edelstahl schwarz lackiert - Abmessung: 190/270 x 100 x H76 cm - Nettogewicht: 141 kg

DT097AR/ MA / SD / SI / TI / CC: zementgrau / Marmoroptik matt / rostbraun / silver / Titan / Eiche hell

Gestell: Stahl schwarz lackiert - Abmessung: 150/230 x 100 x H76 cm - Nettogewicht: 137 kg

© Registriertes Modell (INPI : 20190743)

# AKANTE®

KHEOPS - MILAZZO - NAPOLI - STROMBOLI ©



# KHEOPS - MILAZZO - NAPOLI - STROMBOLI<sup>®</sup>

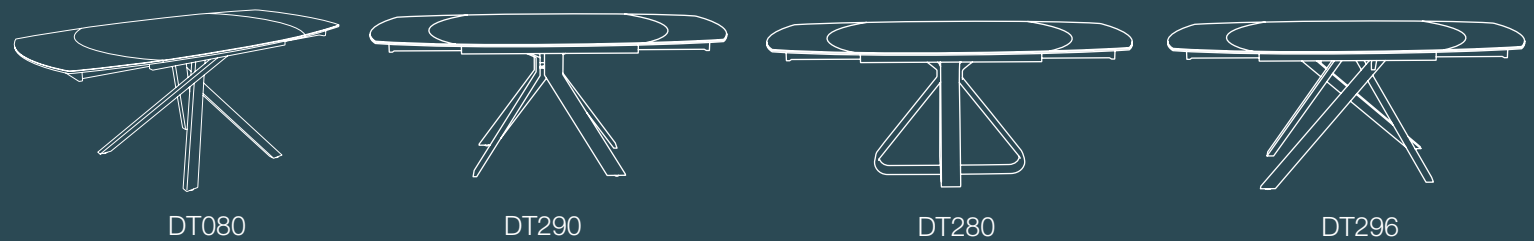

DT080

DT290

DT280

DT296

## TABLE DE REPAS

Plateau en céramique de 3 mm collé sur un verre de 8 mm d'épaisseur, couleurs : Havane (HA), Argile (AR), Marbre Mat (MA), Acier (SD), Silver (SI), Titane (TI), Chêne Clair (CC) ou céramique de 6 mm collé sur un verre de 6 mm d'épaisseur, couleurs : Marbre Fiorentino (MR), Marbre Doro (MD), Marbre Calcatta (MC), Marbre Marquina (MM)

2 rallonges rétractables synchronisées  
Piétement : Acier laqué noir (équipé de patins réglables)

DT081 / DT291 / DT281 / DT297 : Dimensions : 120/180 x 90 x h76 cm      Poids Net : 82 kg  
DT080 / DT290 / DT280 / DT296 : Dimensions : 130/190 x 100 x h76 cm      Poids Net : 102 kg

© Modèle déposé (Réf. INPI : 20234015)

## DINING TABLE

Top plate : Ceramic over glass thickness 3 + 8 mm, colours : Havanna (HA), Argile (AR), Matt marble (MA), Steel dark (SD), Silver (SI), Titanium (TI), Clear oak (CC) or Ceramic over glass thickness 6 + 6 mm, colours : Fiorentino Marble (MR) Doro Marble (MD), Calcatta Marble (MC), Marquina Marble (MM)

Two synchronised pull-out extensions  
Legs : Black lacquered steel (with built-in levellers)

DT081 / DT291 / DT281 / DT297 : Dimensions : 120/180 x 90 x h76 cm      Net Weight : 82 kgs  
DT080 / DT290 / DT280 / DT296 : Dimensions : 130/190 x 100 x h76 cm      Net Weight : 102 kgs

© Registered design (INPI : 20234015)

## ESSTISCH

Tischplatte: Keramik auf Glas Stärke 3 + 8 mm, farben: Havanna (HA), zementgrau (AR), Marmoroptik matt (MA), rostbraun (SD), silver (SI), Titan (TI), eiche hell (CC) oder Keramik auf Glas Stärke 6 + 6 mm : Marmor Fiorentino (MR), Marmor Doro (MD), Marmor Calcatta (MC), Marmor Marquina (MM)

2 synchronisierte einziehbare Verlängerungen  
Gestell: Stahl schwarz lackiert (mit plastikkappe)

DT081 / DT291 / DT281 / DT297: Abmessung: 120/180 x 90 x H76 cm      Nettogewicht: 82 kg  
DT080 / DT290 / DT280 / DT296: Abmessung: 130/190 x 100 x H76 cm      Nettogewicht: 102 kg

© Registriertes Modell (INPI : 20234015)



# AKANTE®

LUNA®



[www.akante.com](http://www.akante.com)



# LUNA<sup>®</sup>

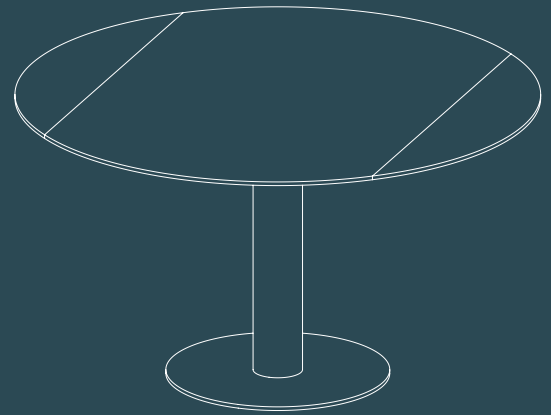

## TABLE DE REPAS

2 rallonges rétractables

DT015-DT017-DT018-DT019 : Dimensions : 90/135 x 135 x h76 cm  
Poids Net : 76 kg

DT033-DT035-DT036-DT037 : Dimensions : 90/150 x 150 x h76 cm  
Poids Net : 98 kg

Finitions pieds : DT015 / DT033 : Acier laqué gris silex  
DT017 / DT035 : Acier laqué noir  
DT018 / DT036 : Acier inoxydable brossé  
DT019 / DT037 : Acier laqué blanc

Finitions plateaux : Céramique SI / TI / AR / MA / SD / CC :  
Silver / Titane / Argile / Marbre / Acier / Chêne clair de 3 mm collée sur un verre  
de 8 mm d'épaisseur

Céramique MM / MC :  
Marbre Marquina / Marbre Calcatta de 6 mm collée sur un verre de 6 mm d'épaisseur

## DINING TABLE

2 pull-out extensions

DT015-DT017-DT018-DT019 : Dimensions : 90/135 x 135 x H76 cm  
Net weight : 76 kgs

DT033-DT035-DT036-DT037 : Dimensions : 90/150 x 150 x H76 cm  
Net weight : 98 kgs

Legs finish : DT015 / DT033 : Flint grey lacquered steel  
DT017 / DT035 : Black lacquered steel  
DT018 / DT036 : Brushed stainless steel  
DT019 / DT037 : White lacquered steel

Top finish : Ceramics SI / TI / AR / MA / SD / CC :  
Silver / Titanium / Argile / Marble / Steel dark / Clear oak over glass thickness 3 + 8 mm

Ceramics MM / MC :  
Marquina marble / Calcatta marble over glass thickness 6 + 6 mm

## ESSTISCH

Mit 2 einziehbaren Auszügen

DT015-DT017-DT018-DT019: Abmessung: 90/135 x 135 x H76 cm  
Nettogewicht: 76 kg

DT033-DT035-DT036-DT037: Abmessung: 90/150 x 150 x H76 cm  
Nettogewicht: 98 kg

Gestellausführungen: DT015 / DT033: Kieselgrau lackierter Edelstahl  
DT017 / DT035: Schwarz lackierter Edelstahl  
DT018 / DT036: gebürsteter Edelstahl  
DT019 / DT037: Weiß lackierter Edelstahl

Obere Platte: Keramik SI / TI / AR / MA / SD / CC:  
Keramik Silber / Titan / Zementgrau / Marmoroptik / Rostbraun / eiche hell auf Glas,  
Stärke 3 + 8 mm

Keramik MM / MC:  
Keramik Marquina marble / Calcatta marble auf Glas, Stärke 6 + 6 mm

© Modèle déposé / Registered design / Registriertes Modell (INPI : 20161761)  
Modèle breveté / Patented model / Patentiertes Modell (Réf. INPI FR1870192)

AKANTE<sup>®</sup>  
www.akante.com

# AKANTE®

ONTARIO®



# ONTARIO<sup>®</sup>

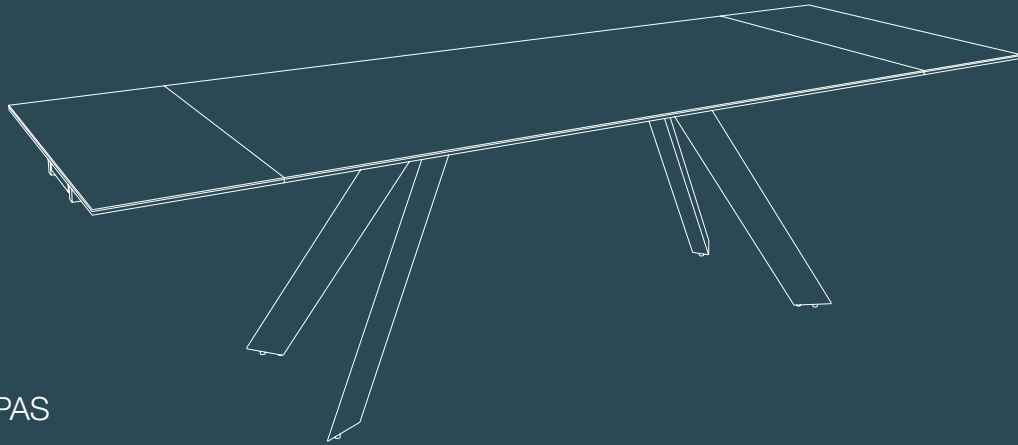

## TABLE DE REPAS

Céramique de 3 mm collée sur un verre de 8 mm d'épaisseur, couleurs : Argile (AR), Marbre Mat (MA), Acier (SD), Silver (SI), Titane (TI), Chêne Clair (CC)  
Piètement : acier laqué noir (équipé de patins réglables)

2 rallonges indépendantes rétractables

DT044 : dimensions 190/270 x 100 x 76 cm - Poids Net : 114 kg

DT045 : dimensions 150/230 x 100 x 76 cm - Poids Net : 90 kg

DT055 : dimensions 190/270 x 100 x 90 cm - Poids Net : 116 kg

DT056 : dimensions 150/230 x 100 x 90 cm - Poids Net : 92 kg

© Modèles déposés (Réf. INPI : 20222320)

## DINING TABLE

Ceramic over glass thickness 3 + 8 mm, colours : Argile (AR), Matt marble (MA), Steel dark (SD), Silver (SI), Titanium (TI), Clear Oak (CC)  
Legs : black lacquered steel (with built-in levellers)

Two independant pull-out extensions

DT044 : dimensions 190/270 x 100 x 76 cm - Net Weight : 114 kgs

DT045 : dimensions 150/230 x 100 x 76 cm - Net Weight : 90 kgs

DT055 : dimensions 190/270 x 100 x 90 cm - Net Weight : 116 kgs

DT056 : dimensions 150/230 x 100 x 90 cm - Net Weight : 92 kgs

© Registered design (INPI : 20222320)

## ESSTISCH

Tischplatte:

Keramik auf Glas Stärke 3 + 8 mm, farben: zementgrau (AR), Marmoroptik matt (MA), rostbraun (SD), silver (SI), Titan (TI), Eiche hell (CC)

Gestell: Stahl schwarz lackiert (mit plastikkappe)

2 voneinander unabhängig einziehbare Verlängerungen

DT044: Abmessung 190/270 x 100 x 76 cm - Nettogewicht: 114 kg

DT045: Abmessung 150/230 x 100 x 76 cm - Nettogewicht: 90 kg

DT055: Abmessung 190/270 x 100 x 90 cm - Nettogewicht: 116 kg

DT056: Abmessung 150/230 x 100 x 90 cm - Nettogewicht: 92 kg

© Registriertes Modell (INPI 20222320)

# AKANTE®

ORLANDO





# ORLANDO

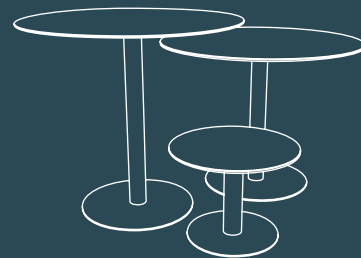

 Gamme ORLANDO CT500 / DT500 / ET500

Disponible en table de bar, table de repas, table basse ou coin canapés, sellette et gigogne.

Gamme large et surtout 100 % personnalisable.

Céramiques AR / MA / SD / SI / TI / CC :

Plateau en céramique argile / marbre mat / acier / silver / titane / chêne clair ép. 3 mm sur verre 6 ou 8 mm

Piètements : Acier laqué noir / Acier laqué taupe / Acier laqué blanc

## TABLE BAR

Ø 75 ou 100 cm x h110 cm  
h90 cm

## TABLE DE REPAS

Ø 100 ou 75 cm x h75 cm

## TABLE BASSE

Ø 75 ou 100 cm x h33 cm  
h40 cm

## TABLE GIGOGNE & BOUT DE CANAPÉ

Ø 40 ou 55 cm x h33 cm  
h40 cm  
h50 cm

\* Existe aussi en forme carrée (DT600)

 The ORLANDO Collection CT500 / DT500 / ET500

Available in snack bar, dining table, coffee table or end table and nest tables.

Diverse selection and 100% customizable.

Ceramics AR / MA / SD / SI / TI / CC :

Tops in ceramic argile / matt marble / steel / silver / titanium / clear oak over glass thickness 3 + 6 or 8 mm

Legs : Black lacquered steel / Taupe lacquered steel / White lacquered steel

## BAR TABLE

Ø 75 or 100 cm x H110 cm  
H90 cm

## DINING TABLE

Ø 100 or 75 cm x H75 cm

## COFFEE TABLE

Ø 75 or 100 cm x H33 cm  
H40 cm

## NEST OF TABLES / END TABLE

Ø 40 or 55 cm x H33 cm  
H40 cm  
H50 cm

\* Also available in square shape (DT600)

 Tischserie ORLANDO CT500 / DT500 / ET500

Erhältlich als Stehtisch, Esstisch, Couchtisch, geeignet auch als Beistell-, Abstell- und Satztisch.

Breites Spektrum und für jeden Gebrauch anpassbar

Erhältlich in den Ausführungen AR / MA / SD / SI / TI / CC:

3 mm Keramikplatte in zementgrau / Marmoroptik matt / rostbraun / silver / Titan / eiche hell auf 6 oder 8 mm starkem Glas

Gestell aus Stahl erhältlich in den Ausführungen: Schwarz, taupe oder weißlackiert

## STEHTISCH

Ø 75 oder 100 cm x H110 cm  
H90 cm

## ESSTISCH

Ø 100 oder 75 cm x H75 cm

## COUCHTISCH

Ø 75 oder 100 cm x H33 cm  
H40 cm

## SATZTISCHE / BEISTELLTISCH

Ø 40 oder 55 cm x H33 cm  
H40 cm  
H50 cm

\* Auch in quadratischer Form erhältlich (DT600)

# AKANTE®

OTTAWA®



# OTTAWA®

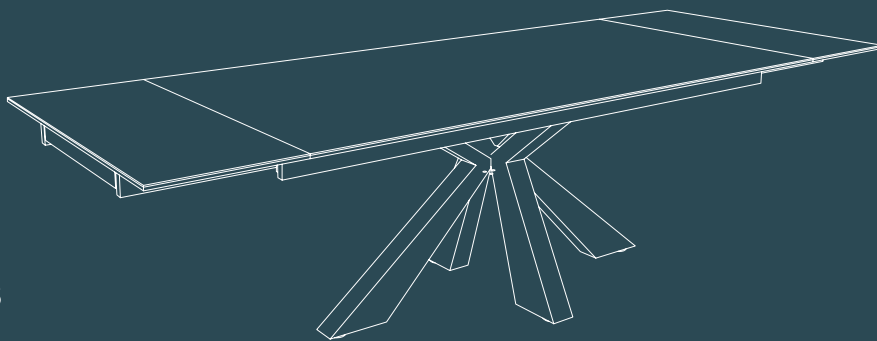

## 🇫🇷 TABLE DE REPAS

Plateau : céramique sur verre épaisseur : 3 + 8 mm - 2 rallonges indépendantes rétractables  
Piètement : équipé de patins réglables

DT040AR / MA : Plateau céramique argile / marbre mat -

Piètement : acier laqué taupe

DT041AR / MA / SD / TI / SI / CC : Plateau céramique argile / marbre mat / acier / titane / silver /  
chêne clair

Piètement : acier laqué noir - Dimensions : 190/270 x 100 x 76 cm - Poids Net : 130.5 kg

DT048AR / MA : Plateau céramique argile / marbre mat - Piètement : acier laqué taupe

DT049AR / MA / SD / TI / SI / CC : Plateau céramique argile / marbre mat / acier / titane / silver /  
chêne clair

Piètement : acier laqué noir - Dimensions : 150/230 x 100 x 76 cm - Poids Net : 126.5 kg

© Modèle déposé (Réf. INPI : 20222320)

## 🇬🇧 DINING TABLE

Top : ceramic over glass 3 + 8 mm - Two independant pull-out extensions

Legs : with built-in levellers

DT040AR / MA : Top in ceramic argile / matt marble - Legs : taupe lacquered steel

DT041AR / MA / SD / TI / SI / CC : Top in ceramic argile / matt marble / steel /  
titanium / silver / light oak

Legs : black lacquered steel - Dimensions : 190/270 x 100 x 76 cm - Net Weight : 130.5 kgs

DT048AR / MA : Top in ceramic argile / matt marble - Legs : taupe lacquered steel

DT049AR / MA / SD / TI / SI / CC : Top in ceramic argile / matt marble / steel / titanium / silver /  
light oak

Legs : black lacquered steel - Dimensions : 150/230 x 100 x 76 cm - Net Weight : 126.5 kgs

© Registered design (INPI : 20222320)

## 🇩🇪 ESSTISCH

3 mm Keramikplatte auf 8 mm starkem Glas - 2 voneinander unabhängig einziehbare Verlängerungen  
Gestell mit plastikkappe

DT040AR / MA: Keramikplatte zementgrau / Marmoroptik matt - Gestell: Stahl taupe lackiert

DT041AR / MA / SD / TI / SI / CC: Keramikplatte zementgrau / Marmoroptik matt / rostbraun / Titan /  
silber / Eiche hell

Gestell: Stahl schwarz lackiert - Abmessung: 190/270 x 100 x 76 cm - Nettogewicht: 130.5 kg

DT048AR / MA: Keramikplatte zementgrau / Marmoroptik matt - Gestell: Stahl taupe lackiert

DT049AR / MA / SD / TI / SI / CC: Keramikplatte zementgrau / Marmoroptik matt / rostbraun / Titan /  
silber / Eiche hell

Gestell: Stahl schwarz lackiert - Abmessung: 150/230 x 100 x 76 cm - Nettogewicht: 126.5 kg

© Registriertes Modell (INPI 20222320)

# AKANTE®

PHOENIX®



# PHOENIX<sup>®</sup>

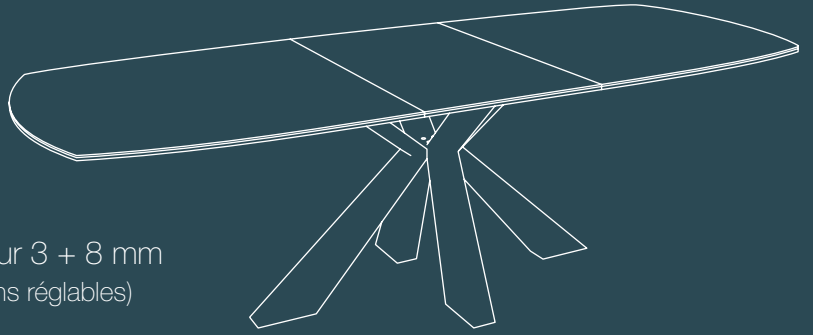

## TABLE DE REPAS

Plateau : Céramique sur verre épaisseur 3 + 8 mm  
Piétement : Acier laqué noir (équipé de patins réglables)  
Une rallonge centrale rétractable

### DT069TI / SI / SD / AR / MA / CC :

Plateau céramique titane / silver / acier / argile / marbre mat / chêne clair  
Dimensions : 160/200 x 100 x h76 cm - Poids : 95 kg

### DT071TI / SI / SD / AR / MA / CC :

Plateau céramique titane / silver / acier / argile / marbre mat / chêne clair  
Dimensions : 200/260 x 100 x h76 cm - Poids : 109 kg

© Modèle déposé (Réf. INPI : 20190743)

## DINING TABLE

Top : Ceramic over glass thickness 3 + 8 mm  
Legs : Black lacquered steel (with built-in levellers)  
One pull-out central extension

### DT069TI / SI / SD / AR / MA / CC :

Tops in ceramic titanium / silver / steel dark / argile / matt marble / clear oak  
Dimenisons : 160/200 x 100 x H76 cm - Net Weight : 95 kgs

### DT071TI / SI / SD / AR / MA / CC :

Tops in ceramic titanium / silver / steel dark / argile / matt marble / clear oak  
Dimenisons : 200/260 x 100 x H76 cm - Net Weight : 109 kgs

© Registered design (INPI : 20190743)

## ESSTISCH

Tischplatte: Keramik auf Glas Dicke 3 + 8 mm  
Gestell: Stahl schwarz lackiert (mit plastikcappe)  
Mit zentraler Verlängerungsplatte

### DT069TI / SI / SD / AR / MA / CC:

Obere Platte aus Keramik Titan / silver / rostbraun / zementgrau / Marmoroptik matt / Eiche hell  
Abmessung: 160/200 x 100 x H76 cm - Nettogewicht: 95 kg

### DT071TI / SI / SD / AR / MA / CC:

Obere Platte aus Keramik Titan / silver / rostbraun / zementgrau / Marmoroptik matt / Eiche hell  
Abmessung: 200/260 x 100 x H76 cm - Nettogewicht: 109 kg

© Registriertes Modell (INPI: 20190743)

# AKANTE®

VALENCIA®



# VALENCIA<sup>®</sup>

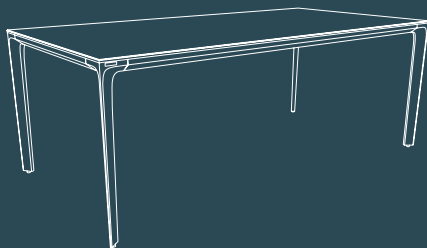

## TABLE DE REPAS

Plateau : Céramique de 3 mm collée sur un verre de 8 mm d'épaisseur, couleurs : Argile (AR), Marbre Mat (MA), Acier (SD), Silver (SI), Titane (TI), Chêne clair (CC)

Céramique pleine masse de 11 mm, couleurs : Marquina (MM), Calcatta (MC)

DT200 / DT204 / DT220 / DT230 / DT240 : Piétement : Acier et Aluminium laqué noir

DT201 / DT205 / DT221 : Piétement : Acier et Aluminium laqué gris anthracite

DT200 / DT201 : Dimensions : 160 x 90 x h74 cm Poids Net : 57.5 kg

DT204 / DT205 : Dimensions : 180 x 90 x h74 cm Poids Net : 74.5 kg

DT220 / DT221 : Dimensions : 200 x 100 x h74 cm Poids Net : 74.5 kg

DT230 : Dimensions : 220 x 100 x h74 cm Poids Net : 82.4 kg

DT240 : Dimensions : 240 x 100 x h74 cm Poids Net : 88.8 kg

© Modèle déposé (Réf. INPI : 20215513)

## DINING TABLE

Top : Ceramic over glass thickness 3 + 8 mm, colours : Argile (AR), Matt marble (MA), Steel dark (SD), Silver (SI), Titanium (TI), Clear oak (CC)

Full body ceramic thickness 11 mm, colours : Marquina (MM), Calcatta (MC), Onyx blue (MO)

DT200 / DT204 / DT220 / DT230 / DT240 : Legs : Black lacquered steel and aluminium

DT201 / DT205 / DT221 : Legs : Anthracite grey lacquered steel and aluminium

DT200 / DT201 : Dimensions : 160 x 90 x H74 cm Net Weight : 57.5 kgs

DT204 / DT205 : Dimensions : 180 x 90 x H74 cm Net Weight : 74.5 kgs

DT220 / DT221 : Dimensions : 200 x 100 x H74 cm Net Weight : 74.5 kgs

DT230 : Dimensions : 220 x 100 x H74 cm Net Weight : 82.4 kgs

DT240 : Dimensions : 240 x 100 x H74 cm Net Weight : 88.8 kgs

© Registered desisgn (INPI : 20215513)

## ESSTISCH

Keramik auf Glas Stärke 3 + 8 mm, farben: zementgrau (AR), Marmoroptik matt (MA), rostbraun (SD), silver (SI), Titan (TI), Eiche hell (CC)

11 mm dicke Vollkeramik, farben: Marquina (MM), Calcatta (MC), Onyx blau (MO)

DT200 / DT204 / DT220 / DT230 / DT240: Gestell: Aluminium und stahl schwarz matt lackiert

DT201 / DT205 / DT221: Gestell: Aluminium und stahl anthrazitgrau matt lackiert

DT200 / DT201: Abmessung: 160 x 90 x H74 cm Nettogewicht: 57.5 kg

DT204 / DT205: Abmessung: 180 x 90 x H74 cm Nettogewicht: 74.5 kg

DT220 / DT221: Abmessung: 200 x 100 x H74 cm Nettogewicht: 74.5 kg

DT230: Abmessung: 220 x 100 x H74 cm Nettogewicht: 82.4 kg

DT240: Abmessung: 240 x 100 x H74 cm Nettogewicht: 88.8 kg

© Registriertes Modell (INPI : 20215513)

# AKANTE®

VANCOUVER®





# VANCOUVER<sup>®</sup>

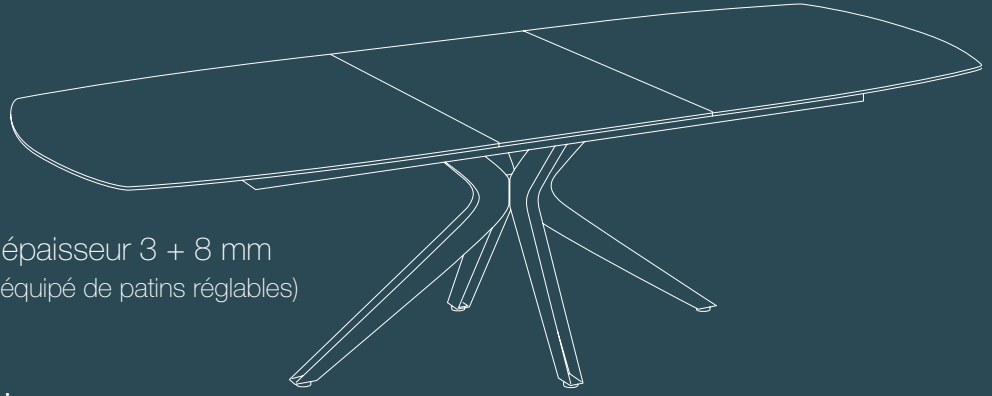

## TABLE DE REPAS

Plateau : Céramique sur verre épaisseur 3 + 8 mm  
Piétement : Acier laqué noir mat (équipé de patins réglables)  
Une rallonge centrale rétractable

### DT088TI / SI / SD / AR / MA / CC :

Plateau céramique titane / silver / acier / argile / marbre mat / chêne clair  
Dimensions : 160/200 x 100 x h76 cm - Poids : 114 kg

### DT089TI / SI / SD / AR / MA / CC :

Plateau céramique titane / silver / acier / argile / marbre mat / chêne clair  
Dimensions : 200/260 x 100 x h76 cm - Poids : 128 kg

© Modèle déposé à l'INPI

## DINING TABLE

Top : Ceramic over glass thickness 3 + 8 mm  
Legs : Black lacquered steel (with built-in levellers)  
One pull-out central extension

### DT088TI / SI / SD / AR / MA / CC :

Tops in ceramic titanium / silver / steel dark / argile / matt marble / clear oak  
Dimenisons : 160/200 x 100 x H76 cm - Net Weight : 114 kgs

### DT089TI / SI / SD / AR / MA / CC :

Tops in ceramic titanium / silver / steel dark / argile / matt marble / clear oak  
Dimenisons : 200/260 x 100 x H76 cm - Net Weight : 128 kgs

© Registered design INPI

## ESSTISCH

Tischplatte: Keramik auf Glas Dicke 3 + 8 mm  
Gestell: Stahl schwarz lackiert (mit plastikcappe)  
Mit zentraler Verlängerungsplatte

### DT088TI / SI / SD / AR / MA / CC:

Obere Platte aus Keramik Titan / silver / rostbraun / zementgrau / Marmoroptik matt / Eiche hell  
Abmessung: 160/200 x 100 x H76 cm - Nettogewicht: 114 kg

### DT089TI / SI / SD / AR / MA / CC:

Obere Platte aus Keramik Titan / silver / rostbraun / zementgrau / Marmoroptik matt / Eiche hell  
Abmessung: 200/260 x 100 x H76 cm - Nettogewicht: 128 kg

© Registriertes Modell INPI

  
AKANTE®



CHAIRES / FAUTEUILS  
CHAIRS / ARMCHAIRS  
STÜHLE UND SESSEL

**CHAIRES ET FAUTEUILS**  
*CHAIRS AND ARMCHAIRS*  
**STÜHLE UND SESSEL**

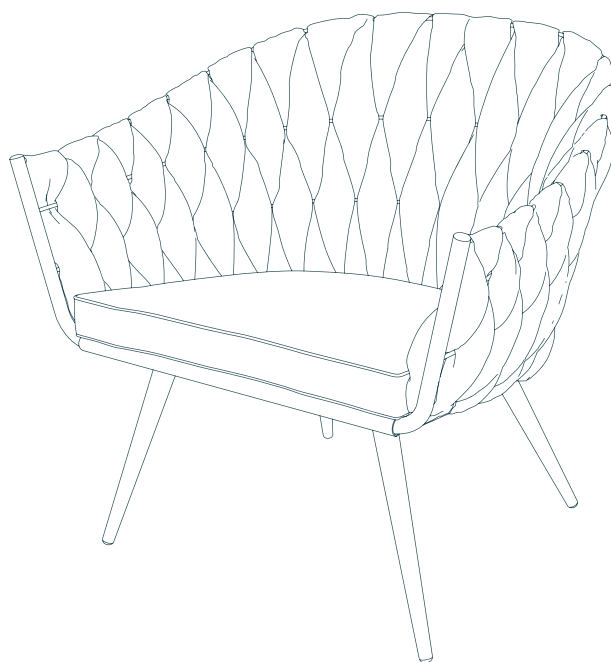

[www.akante.com](http://www.akante.com)

# AKANTE®

AMSTERDAM®





# AKANTE®

BERGEN®



# BERGEN<sup>®</sup>



## 🇫🇷 CHAISE

CH136

Matière : Tissus  
Composition : 100 % polyester - Martindale : 25 000  
Résistance à la lumière : > 4  
Densité mousse : 25 kg/m<sup>3</sup>  
Piétement acier laqué noir

Dimensions : Largeur : 54 cm      Hauteur totale : 86 cm  
                  Profondeur : 62,5 cm      Hauteur assise : 48 cm  
Poids Net : 9,0 kg

CH136 : Assise pivotante à 90° avec rappel

CH136G4 : Velours Gris

CH136G2 : Anthracite

CH136BL : Bleu

CH136G1 : Gris

CH136M3 : Velours Marron

CH136RO : Rouge

CH136M2 : Taupe

CH136J : Jaune

\* VENDU PAR LOT DE 2 CHAISES \*

© Modèle déposé (Réf. INPI : 20231433)



## CHAIR

CH136

Material : Fabrics  
Composition : 100 % polyester - Martindale : 25 000  
Light fastness : > 4  
Foam density : 25 kgs/m<sup>3</sup>  
Legs : Black lacquered steel

Dimensions : Width : 54 cm      Total height : 86 cm  
                  Depth : 62,5 cm      Seat height : 48 cm  
Net Weight : 9,0 kgs

CH136 : Seat pivots 90°

CH136G4 : Grey Velvet

CH136G2 : Charcoal

CH136BL : Blue

CH136G1 : Grey

CH136M3 : Taupe Velvet

CH136RO : Red

CH136M2 : Taupe

CH136J : Yellow

\* SOLD BY 2 PIECES ONLY \*

© Registered design (INPI : 20231433)



## STUHL

CH136

Material: Stoff  
Zusammensetzung: 100 % Polyester - Martindale-Test: 25 000  
Lichtechtheit: > 4  
Schaumstoffdichte: 25 kg/m<sup>3</sup>  
Stuhlbeine: Stahl schwarz lackiert

Abmessung: Breite: 54 cm      Gesamthöhe: 86 cm  
                  Tiefe: 62,5 cm      Sitzhöhe: 48 cm  
Nettogewicht: 9,0 kg

CH136: Sitzfläche um 90° drehbar mit Rücklauffunktion

CH136G4: Grau Samt

CH136G2: Anthrazit

CH136BL: Blau

CH136G1: Grau

CH136M3: Taupe Samt

CH136RO: Rot

CH136M2: Taupe

CH136J: Gelb

\* NUR IM 2-er SET ERHÄLTlich \*

© Registriertes Modell (INPI : 20231433)

# AKANTE®

CHARLESTON®



# CHARLESTON®

## 🇫🇷 CHAISE

Matière : Tissus / velours ras et polyuréthane  
Composition : Tissus 100% polyester - Martindale : 25 000  
Résistance à la lumière : > 4  
Composition PU : 100% polyuréthane - Martindale : 30 000  
Densité mousse 25 kg/m<sup>3</sup>  
Piétement acier laqué noir

Dimensions : Largeur : 59,5 cm      Profondeur : 62 cm  
Hauteur : 84.5 cm      H assise : 48,5 cm  
Poids Net : 9.3 kg

CH097 : Assise pivotante à 90° avec rappel

CH097G1 : Gris  
CH097BL : Bleu  
CH097J : Jaune  
CH097G2 : Anthracite  
CH097M2 : Taupe  
CH097RO : Rouge

CH097G4 : Velours gris  
CH097M3 : Velours taupe

© Modèle déposé (Réf. INPI : 20200478)



## 🇬🇧 CHAIR

Material : Fabric / velvet and polyurethane  
Composition : Fabric 100% polyester - Martindale : 25 000  
Light fastness : > 4  
PU composition : 100% polyurethane - Martindale : 30 000  
Foam density 25 kgs/m<sup>3</sup>  
Legs black lacquered steel

Dimensions : Width : 59,5 cm      Depth : 62 cm  
Height : 84.5 cm      Seat H : 48,5 cm  
Net Weight : 9.3 kgs

CH097 : Seat pivots 90 ° with return

CH097G1 : Grey  
CH097BL : Blue  
CH097J : Yellow  
CH097G2 : Charcoal  
CH097M2 : Taupe  
CH097RO : Red

CH097G4 : Grey velvet  
CH097M3 : Taupe velvet

© Registered design (INPI : 20200478)

## 🇩🇪 STUHL

Material: Stoff oder Velours und Kunstleder  
Zusammensetzung: Stoff 100% Polyester - Martindale: 25 000  
Lichtechtheit > 4  
Kunstleder: 100% Polyurethan - Martindale: 30 000  
Schaumstoffdichte 25 kg/m<sup>3</sup>  
Stuhlbeine: Stahl schwarz lackiert

Abmessung: Breite: 59,5 cm      Tiefe: 62 cm  
Gesamthöhe: 84.5 cm      Sitzhöhe: 48,5 cm  
Nettogewicht: 9.3 kg

CH097: Sitzfläche um 90° drehbar mit Returnfunktion / dreht sich automatisch wieder zurück

CH097G7: Grau  
CH097BL: Blau  
CH097J: Gelb  
CH097G2: Anthrazit  
CH097M2: Taupe  
CH097RO: Rot  
CH097G4: Velours grau  
CH097M3: Velours braun

© Registriertes Modell (INPI : 20200478)



# AKANTE®

CHICAGO®



# CHICAGO<sup>®</sup>



## CHAISE CH093

Matière : Tissus / velours ras et polyuréthane  
Composition : Tissus : 100% polyester  
Martindale Tissus : 25 000  
Résistance à la lumière : > 4  
Composition PU : 100% polyuréthane  
Martindale PU : 30 000  
Densité mousse : 25 kg/m<sup>3</sup>

Piètement : Acier laqué noir

Dimensions :

Largeur : 60 cm                      Profondeur : 57 cm  
Hauteur totale : 83 cm              Hauteur assise : 48,5 cm              Poids Net : 9.5 kg

CH093 : Assise pivotante à 90° avec rappel

CH093G1 : Gris  
CH093BL : Bleu

CH093G2 : Anthracite  
CH093M2 : Taupe

CH093J : Jaune  
CH93RO : Rouge

CH093G4 : Velours Gris  
CH093M3 : Velours Taupe

© Modèle déposé (Réf. INPI : 20190743)

## CHAIR CH093

Material : Fabric / velvet and polyurethane  
Composition : Fabric : 100% polyester  
Fabric Martindale : 25 000  
Light fastness : > 4  
PU composition : 100% polyurethane  
PU Martindale : 30 000  
Foam density : 25 kgs/m<sup>3</sup>

Legs : Black lacquered steel

Dimensions :

Width : 60 cm                      Depth : 57 cm  
Total height : 83 cm              Seat height : 48,5 cm              Net weight : 9.5 kgs

CH093 : Seat pivot 90° with return

CH093G1 : Grey ( CH095 for UK standard )

CH093G2 : Charcoal ( CH095 for UK standard )

CH093BL : Blue ( CH095 for UK standard )

CH0093J : Yellow ( CH095 for UK standard )

CH093M2 : Taupe ( CH095 for UK standard )

CH093RO : Red ( not available in UK standard )

CH093G4 : Grey velvet ( not available in UK standard )

CH093M3 : Taupe velvet( not available in UK standard )

© Registered design (INPI : 20190743)

## STUHL CH093

Material: Stoff oder Velours und Kunstleder  
Zusammensetzung: Stoff 100% Polyester  
Martindale-Test Stoff: 25 000  
Lichtechtheit: > 4  
Kunstleder: 100% Polyurethan  
Martindale-Test PU: 30 000  
Schaumstoffdichte: 25 kg/m<sup>3</sup>

Stuhlbeine: Stahl schwarz lackiert

Abmessung:

Breite: 60 cm                      Tiefe: 57 cm  
Gesamthöhe: 83 cm              Sitzhöhe: 48,5 cm              Nettogewicht: 9.5 kg

CH093: Sitzfläche um 90° drehbar mit Returnfunktion

CH093G1: Grau  
CH093BL: Blau

CH093G2: Anthrazit  
CH093M2: Taupe

CH093J: Gelb  
CH093RO: Rot

CH093M3: Velours braun  
CH093G4: Velours grau

© Registriertes Modell (INPI : 20190743)

# AKANTE®

FOLD®



# FOLD®



## CHAISE

Chaise pliable en polycarbonate

CH035TR : Transparent  
CH035G : Gris fumé

Largeur : 48 cm  
Profondeur : 51 cm

Hauteur : 81 cm  
Hauteur assise : 46 cm

Poids Net : 4,5 kg

\* VENDU PAR LOT DE 2 CHAISES \*

© Modèle déposé (Réf. INPI : 20173908)

CH035

## CHAIR

Folding polycarbonate chair

CH035TR : Transparent  
CH035G : Smoked grey

Width : 48 cm  
Depth : 51 cm

Height : 81 cm  
Seat height : 46 cm

Net Weight : 4,5 kgs

\* SOLD BY 2 PIECES ONLY \*

© Registered design (INPI : 20173908)

CH035

## STUHL

Klappstuhl aus Polycarbonat

CH035TR: Transparent  
CH035G: grau getönt

Breite: 48 cm  
Tiefe: 51 cm

Höhe: 81 cm  
Sitzhöhe: 46 cm

Nettogewicht: 4,5 kg

\* NUR IM 2-er SET ERHÄLTlich \*

© Registriertes Modell (INPI : 20173908)

CH035

# AKANTE

FRISCO®



# FRISCO®



## CHAISE

CH111

Matière : Tissus ou velours ras  
Composition : Tissus : 100 % polyester - Martindale : 25 000  
Résistance à la lumière : > 4  
Densité mousse : 25 kg/m<sup>3</sup>  
Piètement acier laqué noir

Dimensions : Largeur : 54 cm      Hauteur totale : 86,5 cm  
                  Profondeur : 58 cm      Hauteur assise : 48 cm  
Poids Net : 5,0 kg

CH111 : Assise pivotante à 90° avec rappel

CH111G4 : Velours ras Gris      CH111G2 : Anthracite      CH111BL : Bleu      CH111G1 : Gris  
CH111M3 : Velours ras Marron      CH111RO : Rouge      CH111M2 : Taupe      CH111J : Jaune

\* VENDU PAR LOT DE 2 CHAISES \*

© Modèle déposé (Réf. INPI : 20205317)



## CHAIR

CH111

Material : Fabrics or velvets  
Composition : Fabric : 100 % polyester - Martindale : 25 000  
Light fastness : > 4  
Foam density : 25 kgs/m<sup>3</sup>  
Legs : Black lacquered steel

Dimensions : Width : 54 cm      Total height : 86,5 cm  
                  Depth : 58 cm      Seat height : 48 cm  
Net Weight : 5,0 kgs

CH111 : Seat pivots 90 °

CH111G4 : Grey Velvet      CH111G2 : Charcoal      CH111BL : Blue      CH111G1 : Grey  
CH111M3 : Taupe Velvet      CH111RO : Red      CH111M2 : Taupe      CH111J : Yellow

\* SOLD BY 2 PIECES ONLY \*

© Registered design (INPI : 20205317)



## STUHL

CH111

Material: Stoff oder Kurzsamt  
Zusammensetzung: Stoff: 100 % Polyester - Martindale-Test: 25 000  
Lichtechtheit: > 4  
Schaumstoffdichte: 25 kg/m<sup>3</sup>  
Stuhlbeine: Stahl schwarz lackiert

Abmessung: Breite: 54 cm      Gesamthöhe: 68,5 cm  
                  Tiefe: 58 cm      Sitzhöhe: 468 cm  
Nettogewicht: 5,0 kg

CH111: Sitzfläche um 90° drehbar mit Rücklauffunktion

CH111G4: Grau Samt      CH111G2: Anthrazit      CH111BL: Blau      CH111G1: Grau  
CH111M3: Taupe Samt      CH111RO: Rot      CH111M2: Taupe      CH111J: Gelb

\* NUR IM 2-er SET ERHÄLTlich \*

© Registriertes Modell (INPI : 20205317)

# AKANTE®

## HÉLION®



# HÉLION<sup>®</sup>

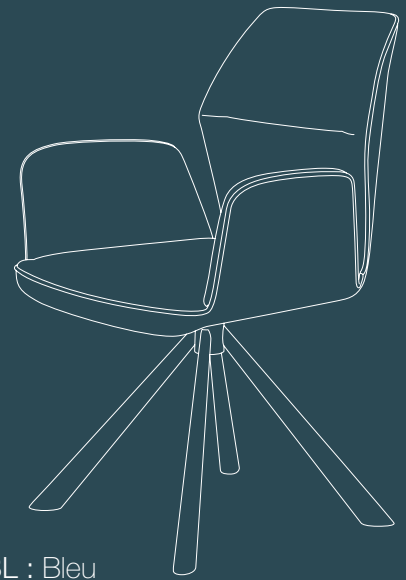

## 🇫🇷 CHAISE

CH131

Matière : Tissus ou velours ras  
Composition : Tissus 100% polyester - Martindale: 25 000  
Résistance à la lumière : > 4  
Densité mousse 25 kg/m<sup>3</sup>

Dimensions : Largeur : 61 cm Profondeur : 61,5 cm  
Hauteur : 91 cm H assise : 48,5 cm  
Poids Net : 10,5 kg

Assise pivotante à 90° avec rappel - Piétement acier laqué noir

CH131G1 : Gris  
CH131G4 : Velours gris  
CH131J : Jaune  
CH131G2 : Anthracite  
CH131M3 : Velours marron  
CH131RO : Rouge  
CH131BL : Bleu  
CH131M2 : Taupe

\* VENDU PAR LOT DE 2 CHAISES \*

© Modèle déposé (Réf. INPI : 20222320)

## 🇬🇧 CHAIR

CH131

Material : Fabric or velvet  
Composition : Fabric 100% polyester - Martindale : 25 000  
Light fastness : > 4  
Foam density 25 kgs/m<sup>3</sup>

Dimensions : Width : 61 cm Depth : 61,5 cm  
Height : 91 cm Seat H : 48,5 cm  
Net Weight : 10,5 kgs

Seat pivots 90° - Black lacquered steel leg

CH131G1 : Grey  
CH131G4 : Grey velvet  
CH131J : Yellow  
CH131G2 : Charcoal  
CH131M3 : Brown velvet  
CH131RO : Red  
CH131BL : Blue  
CH131M2 : Taupe

\* SOLD BY 2 PIECES ONLY \*

© Registered design (INPI : 20222320)

## 🇩🇪 STUHL

CH131

Material: Stoff oder Velours  
Zusammensetzung: Stoff 100% Polyester - Martindale: 25 000  
Lichtechtheit: > 4  
Schaumdichte 25 kg/m<sup>3</sup>

Abmessung: Breite: 61 cm Tiefe: 61,5 cm  
Gesamthöhe: 91 cm Sitzhöhe: 48,5 cm  
Nettogewicht: 10,5 kg

Sitzfläche 90° drehbar mit Returnfunktion - Stuhlbeine aus Stahl schwarz lackiert

CH131G1: Grau  
CH131G4: Velours grau  
CH131J: Gelb  
CH131G2: Anthrazit  
CH131M3: Velours braun  
CH131RO: Rot  
CH131BL: Blau  
CH131M2: Taupe

\* NUR IM 2-er SET ERHÄLTlich \*

© Registriertes Modell (INPI : 20222320)



# AKANTE®

LAFAYETTE®



# LAFAYETTE<sup>®</sup>

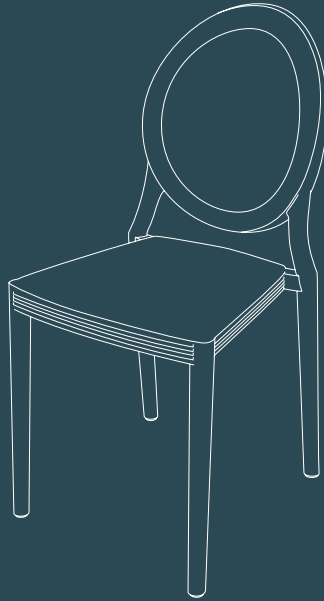

## CHAISE CH032

Chaise Polycarbonate (chaises empilables)

Dimensions :            Largeur :        41 cm            Profondeur :    51 cm  
                                 H. assise :     47 cm            H. totale :       90 cm  
Poids Net : 4,6 kg

CH032TR :            Transparent  
CH032G :            Gris fumé

\* VENDU PAR LOT DE 2 CHAISES \*

© Modèle déposé (Réf. INPI : 20190743)

## CHAIR CH032

Polycarbonate chair (stacking chairs)

Dimensions :            Width :            41 cm            Depth :            51 cm  
                                 Seat height :    47 cm            Total height :    90 cm  
Net Weight : 4,6 kgs

CH032TR :            Transparent  
CH032G :            Smoked grey

\* SOLD BY 2 PIECES ONLY \*

© Registered design (INPI : 20190743)

## STHUL CH032

Stuhl aus Polycarbonat (stapelbar)

Abmessung:            Breite:            41 cm            Tiefe:            51 cm  
                                 Sitzhöhe:        47 cm            Gesamthöhe:    90 cm  
Nettogewicht: 4,6 kg

CH032TR:            Transparent  
CH032G:            Grau getönt

\* NUR IM 2-er SET ERHÄLTlich \*

© Registriertes Modell (INPI : 20190743)

# AKANTE®

MIAMI®



# MIAMI<sup>®</sup>

## 🇫🇷 CHAISE CH0100 - CH101

Matière : Tissus  
Composition : Tissus : 100 % polyester  
Martindale : 25 000  
Résistance à la lumière : > 4  
Densité mousse : 25 kg/m<sup>3</sup>  
Piétement : Acier laqué noir

Dimensions : Largeur : 52 cm      Hauteur totale : 90 cm  
Profondeur : 63 cm      Hauteur assise : 48,5 cm



CH100 : Assise fixe  
CH101 : Assise pivotante à 90° avec rappel

CH100/101G1 : Gris      CH100/101G2 : Anthracite      CH100/101BL : Bleu  
CH100/101J : Jaune      CH100/101RO : Rouge      CH100/101M2 : Taupe  
CH100/101G4 : Velours gris      CH100/101M3 : Velours marron

\* VENDU PAR LOT DE 2 CHAISES \*

© Modèle déposé (Réf. INPI : 20205317)

## 🇬🇧 CHAIR CH0100 - CH101

Material : Fabric  
Composition : Fabric : 100 % polyester  
Martindale : 25 000  
Light fastness : > 4  
Foam density : 25 kgs/m<sup>3</sup>  
Legs : Black lacquered steel

Dimensions : Width : 52 cm      Total height : 90 cm  
Depth : 63 cm      Seat height : 48,5 cm

Net Weight : 7,8 kgs

CH100 : Fixed seat  
CH101 : Seat pivots 90 °

CH100/101G1 : Grey      CH100/101G2 : Charcoal      CH100/101BL : Blue  
CH100/101J : Yellow      CH100/101RO : Red      CH100/101M2 : Taupe  
CH100/101G4 : Grey Velvet      CH100/101M3 : Taupe velvet

\* SOLD BY 2 PIECES ONLY \*

© Registered design (INPI : 20205317)

## 🇩🇪 STUHL CH0100 - CH101

Material: Stoff  
Zusammensetzung: Stoff: 100 % Polyester  
Martindale-Test: 25 000  
Lichtecktheit: > 4  
Schaumstoffdichte: 25 kg/m<sup>3</sup>  
Stuhlbeine: Edelstahl schwarz lackiert

Abmessung: Breite: 52 cm      Gesamthöhe: 90 cm  
Tiefe: 63 cm      Sitzhöhe: 48,5 cm

Nettogewicht: 7,8 kg

CH100: Sitzfläche fix  
CH101: Sitzfläche 90° drehbar mit Returnfunktion

CH100/101G1: Grau      CH100/101G2: Anthrazit      CH100/101BL: Blau  
CH100/101J: Gelb      CH100/101RO: Rot      CH100/101M2: Taupe  
CH100/101G4 : Grau Samt      CH100/101M3 : Taupe Samt

\* NUR IM 2-er SET ERHÄLTlich \*

© Registriertes Modell (INPI : 20205317)

# AKANTE®

NEPTUNE®



# NEPTUNE<sup>®</sup>

## FAUTEUIL

AC040

Structure en acier laqué noir mat  
Assise en contreplaqué et tissus 100% polyester  
Densité mousse 25 kg/m<sup>3</sup>

Dimensions : Largeur 72 cm  
Profondeur 64 cm  
Hauteur 73 cm  
H.assise 42 cm

AC040BL3 : Tissus bleu marine  
AC040O2 : Tissus orange

AC040GR3 : Tissus gris  
AC040VC : Tissus vert caraïbes



© Modèle déposé (Réf. INPI : 20200478)

## ARMCHAIR

AC040

Structure in black lacquered steel  
Seat in plywood and 100% polyester fabrics  
Foam density 25 kgs/m<sup>3</sup>

Dimensions : Width 72 cm  
Depth 64 cm  
Height 73 cm  
Seat height 42 cm

AC040BL3 : Dark blue  
AC040O2 : Orange

AC040GR3 : Grey  
AC040VC : Caribbean green

© Registered design (INPI : 20200478)

## SESSEL

AC040

Struktur aus schwarz lackiertem Stahl  
Sitz aus Sperrholz und Stoff 100% Polyester  
Schaumdichte 25 kg/m<sup>3</sup>

Abmessung: Breite 72 cm  
Tiefe 64 cm  
Gesamthöhe 73 cm  
Sitzhöhe 42 cm

AC040BL3: Dunkelblauer Stoff  
AC040O2: Orangener Stoff

AC040GR3: Grauer Stoff  
AC040VC: Karibikgrüner Stoff

© Registriertes Modell (INPI : 20200478)

# AKANTE®

NEW YORK®



# NEW YORK®



## 🇫🇷 CHAISE CH080 - CH081

Matière : Tissus / velours ras et polyuréthane

Composition : Tissus : 100 % polyester - Martindale : 25 000  
Résistance à la lumière : > 4  
Composition PU : 100% polyuréthane - Martindale : 30 000  
Densité mousse : 25 kg/m<sup>3</sup>  
Piètement : Acier laqué noir

Dimensions : Largeur : 50 cm Hauteur totale : 86 cm  
Profondeur : 63 cm Hauteur assise : 48 cm

Poids Net : 6,5 kg

CH080 : Assise fixe - CH081 : Assise pivotante à 90° avec rappel

CH080/81G1 : Gris CH080/81G2 : Anthracite CH080/81M3 : Velours Taupe  
CH080/81BL : Bleu CH080/81M2 : Taupe  
CH080/81J : Jaune CH080/81RO : Rouge

© Modèle déposé (Réf. INPI : 20190743)

## 🇬🇧 CHAIR CH080 - CH081

Material : Fabric / velvet and polyurethane

Composition : Fabric : 100 % polyester - Martindale : 25 000  
Light fastness : > 4  
PU composition : 100% polyurethane - Martindale : 30 000  
Foam density : 25 kgs/m<sup>3</sup>  
Legs : Black lacquered steel

Dimensions : Width : 50 cm Total height : 86 cm  
Depth : 63 cm Seat height : 48 cm

Net Weight : 6,5 kgs

CH080 : Fixed seat - CH081 : Seat pivots 90°

CH080/81G : Grey CH080/81G2 : Charcoal CH080/81M3 : Taupe velvet  
CH080/81BL : Blue CH080/81M2 : Taupe  
CH080/81J : Yellow CH080/81RO : Red

© Registered design (INPI : 20190743)

## 🇩🇪 STUHL CH080 - CH081

Material: Stoff / Samt und Kunstleder

Zusammensetzung: Stoff: 100 % Polyester - Martindale-Test: 25 000  
Lichtechtheit: > 4  
Kunstleder: 100% Polyurethan  
Schaumstoffdichte: 25 kg/m<sup>3</sup> - Martindale-Test: 30 000  
Stuhlbeine: Stahl schwarz lackiert

Abmessung: Breite: 50 cm Gesamthöhe: 86 cm  
Tiefe: 63 cm Sitzhöhe: 48 cm

Nettogewicht: 6,5 kg

CH080: Sitzfläche fix - CH081: Sitzfläche 90° drehbar mit Returnfunktion

CH080/81G1: Grau CH080/81G2: Anthrazit CH080/81M3: Taupe Samt  
CH080/81BL: Blau CH080/81M2: Taupe  
CH080/81J: Gelb CH080/81RO: Rot

© Registriertes Modell (INPI: 20190743)



# AKANTE

NORFOLK®



# NORFOLK®

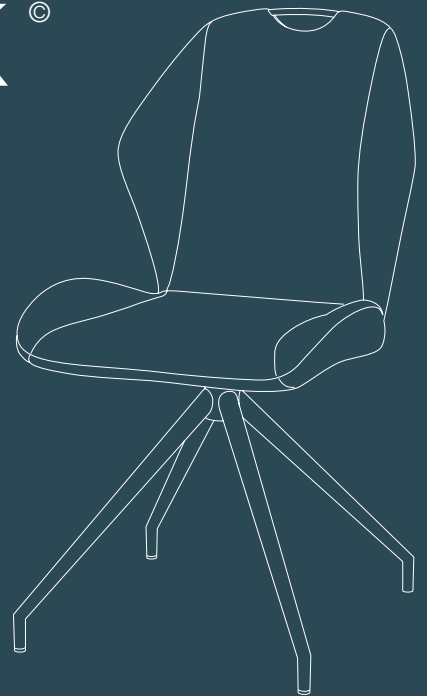

## 🇫🇷 CHAISE

Matière : Tissus et Simili-cuir  
Composition : Tissus : 100% polyester - Martindale : 25 000  
Résistance à la lumière : > 4  
Simili-cuir : 50% polyuréthane / 35% polyester / 15% coton  
Densité mousse 28 kg/m<sup>3</sup> - Martindale : 30 000  
Piétement acier laqué noir

Dimensions : Largeur : 48 cm Profondeur : 61 cm  
Hauteur : 91 cm H assise : 47 cm  
Poids Net : 7,9 kg

CH083 : Assise pivotante à 90° avec rappel  
CH083G1 : Gris CH083G2 : Anthracite  
CH083BL : Bleu CH083M2 : Taupe  
CH083J : Jaune CH083RO : Rouge

\* VENDU PAR LOT DE 2 CHAISES \*

© Modèle déposé (Réf. INPI : 20215513)

## 🇬🇧 CHAIR

Material: fabric and imitation leather  
Composition : Fabric : 100% polyester - Martindale : 25 000  
Light fastness : > 4  
Imitation leather : 50% polyurethane / 35% polyester / 15% cotton  
Foam density 28 kgs/m<sup>3</sup> - Martindale : 30 000  
Legs black lacquered steel

Dimensions : Width : 48 cm Depth: 61 cm  
Height: 91 cm Seat H: 47 cm  
Net Weight : 7,9 kgs

CH083 : Seat pivots 90 ° with return  
CH083G1 : Grey CH083G2 : Charcoal  
CH083BL : Blue CH083M2 : Taupe  
CH083J : Yellow CH083RO : Red

\* SOLD BY 2 PIECES ONLY \*

© Registered design (INPI : 20215513)

## 🇩🇪 STUHL

Material: Stoff und Kunstleder  
Zusammensetzung: Stoff: 100% Polyester - Martindale : 25 000  
Lichtechtheit > 4  
Kunstleder: 50% Polyurethan / 35% Polyester / 15% Baumwolle  
Schaumdichte 28 kg/m<sup>3</sup> - Martindale : 30 000  
Fußgestell: Stahl schwarz lackiert

Abmessung: Breite: 48 cm Tiefe: 61 cm  
Gesamthöhe: 91 cm Sitzhöhe: 47 cm  
Nettogewicht: 7,9 kg

CH083: Sitzfläche um 90° drehbar / dreht sich automatisch wieder zurück  
CH083G1: Grau CH083G2: Anthrazit  
CH083BL: Blau CH083M2: Taupe  
CH083J: Gelb CH083RO: Rot

\* NUR IM 2-er SET ERHÄLTlich \*

© Registriertes Modell (INPI : 20215513)

# AKANTE®

NOTTINGHAM®



# NOTTINGHAM<sup>®</sup>



## CHAISE CH025

Matière : Tissus  
Composition : 100 % polyester - Martindale : 60 000  
Densité mousse : 25 kg/m<sup>3</sup>  
Résistance à la lumière : 5/5  
Résistance au boulochage : 5/5  
Résistance de la couleur au frottement : 5/5  
Piètement acier laqué noir

Dimensions : Largeur : 60 cm      Hauteur totale : 80 cm  
                  Profondeur : 60 cm      Hauteur assise : 49 cm  
Poids Net : 9 kg

CH025 : Assise pivotante à 90° avec rappel

CH025BC : Blanc cassé      CH025BLU : Bleu      CH025GCL : Gris clair  
CH025BG : Beige      CH025DG : Anthracite      CH025OC : Ocre      CH025TE : Terracotta

\* VENDU PAR LOT DE 2 CHAISES \*

© Modèle déposé (Réf. INPI : 20231433)

## CHAIR CH025

Material : Fabrics  
Composition : 100 % polyester - Martindale : 60 000  
Foam density : 25 kgs/m<sup>3</sup>  
Light fastness : 5/5  
Pilling resistance : 5/5  
Color fastness to rubbing : 5/5  
Legs : Black lacquered steel

Dimensions : Width : 60 cm      Total height : 80 cm  
                  Depth : 60 cm      Seat height : 49 cm  
Net Weight : 9 kgs

CH025 : Seat pivots 90°

CH025BC : Off-white      CH025BLU : Blue      CH025GCL : Light grey  
CH025BG : Beige      CH025DG : Charcoal      CH025OC : Ocre      CH025TE : Terracotta

\* SOLD BY 2 PIECES ONLY \*

© Registered design (INPI : 20231433)

## STUHL CH025

Material: Stoff  
Zusammensetzung: 100 % Polyester - Martindale-Test: 60 000  
Schaumstoffdichte: 25 kg/m<sup>3</sup>  
Lichtechtheit: 5/5  
Beständigkeit gegen Knötchenbildung : 5/5  
Farbbeständigkeit bei Reibung : 5/5  
Stuhlbeine: Stahl schwarz lackiert

Abmessung: Breite: 60 cm      Gesamthöhe: 80 cm  
                  Tiefe: 60 cm      Sitzhöhe: 49 cm  
Nettogewicht: 9 kg

CH025: Sitzfläche um 90° drehbar mit Rücklauffunktion

CH025BC: Off-white      CH025BLU: Blau      CH025GCL: Hell grau  
CH025BG: Beige      CH025DG: Anthrazit      CH025OC: Ocre      CH025TE: Terracotta

\* NUR IM 2-er SET ERHÄLTlich \*

© Registriertes Modell (INPI : 20231433)

# AKANTE®

OCTAVE®



# OCTAVE<sup>®</sup>



CH028BL1 : Bleu

Blue

Blau

CH028VE : Vert pastel

Pastel green

Pastelgrün

CH028O : Orange

Orange

Orange

CH028B1 : Noir

Black

Schwarz

CH028W : Blanc

White

Weiß

CH028T : Taupe

Taupe

Taupe

## CHAISE

CH028

Chaise en Polypropylène (chaises empilables)

Largeur : 60 cm

Hauteur : 76 cm

Profondeur : 55 cm

Hauteur assise : 45 cm

Poids Net : 4,8 kg

© Modèle déposé (Réf. INPI : 20231433)

## CHAIR

CH028

Polypropylene chair (stacking chairs)

Width : 60 cm

Height : 76 cm

Depth : 55 cm

Seat height : 45 cm

Net Weight: 4,8 kgs

© Registered design (INPI : 20231433)

## STUHL

CH028

Stuhl aus Polypropylen (stapelbar)

Breite: 60 cm

Höhe: 76 cm

Tiefe: 55 cm

Sitzhöhe: 45 cm

Nettogewicht: 4,8 kg

© Registriertes Modell (INPI : 20231433)

# AKANTE®

OSLO®



# OSLO<sup>®</sup>



## CHAISE CH117 / CH119

Matière : Tissus ou velours ras  
Composition : Tissus 100% polyester - Martindale: 25 000  
Résistance à la lumière : > 4  
Densité mousse 25 kg/m<sup>3</sup>

Dimensions : Largeur : 54 cm Profondeur : 58 cm  
Hauteur : 86 cm H assise : 47 cm  
Poids Net : 9,9 kg

CH117 : Assise pivotante à 90° avec rappel - Piétement acier laqué noir  
CH119 : Assise pivotante à 90° avec rappel - Piétement acier effet bois

CH117/119G1 : Gris  
CH117/119G4 : Velours gris  
CH117J : Jaune  
CH117/119G2 : Anthracite  
CH117/119M3 : Velours marron  
CH117RO : Rouge

CH117/119M2 : Taupe

CH117BL : Bleu

\* VENDU PAR LOT DE 2 CHAISES \*

© Modèle déposé (Réf. INPI : 20215513)

## CHAIR CH117 / CH119

Material : Fabric or velvet  
Composition : Fabric 100% polyester - Martindale : 25 000  
Light fastness : > 4  
Foam density 25 kgs/m<sup>3</sup>

Dimensions : Width : 54 cm Depth : 58 cm  
Height : 86 cm Seat H : 47 cm  
Net Weight : 9,9 kgs

CH117 : Seat pivots 90 ° - Black lacquered steel leg  
CH119 : Seat pivots 90 ° - Wood effect steel base

CH117/119G1 : Grey  
CH117/119G4 : Grey velvet  
CH117J : Yellow  
CH117/119G2 : Charcoal  
CH117/119M3 : Brown velvet  
CH117RO : Red

CH117/119M2 : Taupe

CH117BL : Blue

\* SOLD BY 2 PIECES ONLY \*

© Registered design (INPI : 20215513)

## STUHL CH117 / CH119

Material: Stoff oder Velours  
Zusammensetzung: Stoff 100% Polyester - Martindale : 25 000  
Lichtechtheit > 4  
Schaumdichte 25 kg/m<sup>3</sup>

Abmessung: Breite: 54 cm Tiefe: 58 cm  
Gesamthöhe: 86 cm Sitzhöhe: 47 cm  
Nettogewicht: 9,9 kg

CH117: Sitzfläche 90° drehbar mit Returnfunktion - Stuhlbeine aus Stahl schwarz lackiert  
CH119: Sitzfläche 90° drehbar mit Returnfunktion - Stuhlbeine aus Stahl mit Holz-Optik

CH117/119G1: Grau  
CH117/119G4: Velours grau  
CH117J: Gelb  
CH100/101G2: Anthrazit  
CH117/119M3: Velours braun  
CH117RO: Rot  
CH117/119M2: Taupe  
CH117BL: Blau

\* NUR IM 2-er SET ERHÄLTlich \*

© Registriertes Modell (INPI : 20215513)



# AKANTE®

PALMA®



# PALMA<sup>®</sup>



## CHAISE CH204

Matière : Composition PU : 100% polyuréthane  
Composition : Martindale PU : 30 000  
Résistance à la lumière : > 4  
Densité mousse : 40 kg/m<sup>3</sup>  
Piétement acier inoxydable

Dimensions : Largeur : 71 cm Hauteur totale : 124 cm  
Profondeur : 64 cm Hauteur assise : Réglable

Poids Net : 25 kg

© Modèle déposé (Réf. INPI : 20215513)

## CHAIR CH204

Material : PU composition : 100% polyurethane  
Composition : PU Martindale : 30 000  
Light fastness : > 4  
Foam density : 40 kgs/m<sup>3</sup>  
Legs : Black lacquered steel

Dimensions : Width : 71 cm Total height : 124 cm  
Depth : 64 cm Seat height : Adjustable

Net Weight : 25 kgs

© Registered design (INPI : 20215513)

## STUHL CH204

Material: PU: 100% Polyurethan  
Zusammensetzung: Martindale-Test PU: 30 000  
Lichtechtheit: > 4  
Schaumstoffdichte: 40 kg/m<sup>3</sup>  
Stuhlbeine: Stahl

Abmessung: Breite: 71 cm Gesamthöhe: 124 cm  
Tiefe: 64 cm Sitzhöhe: verstellbare

Nettogewicht: 25 kg

© Registriertes Modell (INPI : 20215513)

# AKANTE®

PALMA®



# PALMA<sup>®</sup>



## CHAISE CH204

Matière :  
Composition : Composition PU : 100% polyuréthane  
Martindale PU : 30 000  
Résistance à la lumière : > 4  
Densité mousse : 40 kg/m<sup>3</sup>  
Piétement acier inoxydable

Dimensions : Largeur : 71 cm      Hauteur totale : 124 cm  
Profondeur : 64 cm      Hauteur assise : Réglable

Poids Net : 20 kg

© Modèle déposé (Réf. INPI : 20215513)

## CHAIR CH204

Material :  
Composition : PU composition : 100% polyurethane  
PU Martindale : 30 000  
Light fastness : > 4  
Foam density : 40 kgs/m<sup>3</sup>  
Legs : Black lacquered steel

Dimensions : Width : 71 cm      Total height : 124 cm  
Depth : 64 cm      Seat height : Adjustable

Net Weight : 20 kgs

© Registered design (INPI : 20215513)

## STUHL CH204

Material:  
Zusammensetzung: PU: 100% Polyurethan  
Martindale-Test PU: 30 000  
Lichtechtheit: > 4  
Schaumstoffdichte: 40 kg/m<sup>3</sup>  
Stuhlbeine: Stahl

Abmessung: Breite: 71 cm      Gesamthöhe: 124 cm  
Tiefe: 64 cm      Sitzhöhe: verstellbare

Nettogewicht: 20 kg

© Registriertes Modell (INPI : 20215513)

# AKANTE®

VEGAS - SAN FRANCISCO®



# VEGAS - SAN FRANCISCO®



CH045/CH047

## FR TABOURET DE BAR

Matière : Tissus et polyuréthane  
Composition : Tissus : 100% polyester - Martindale : 25 000 - Résistance à la lumière : > 4  
Composition PU : 100% polyuréthane - Martindale : 30 000  
Densité mousse : 25 kg/m<sup>3</sup>  
Piétement : Acier laqué noir

### VEGAS

CH045 : Dimensions : L43 x P45 x H100 cm Hauteur assise : 65 cm Poids Net : 7,2 kg  
CH047 : Dimensions : L43 x P45 x H110 cm Hauteur assise : 75 cm Poids Net : 7,6 kg

### SAN FRANCISCO

CH145 : Dimensions : L45 x P45 x H100 cm Hauteur assise : 65 cm Poids Net : 8,35 kg  
CH147 : Dimensions : L45 x P45 x H110 cm Hauteur assise : 75 cm Poids Net : 8,75 kg

Assise pivotante à 90° avec rappel

CH045 / CH145G1 : Gris

CH045 / CH145G2 : Anthracite

CH045 / CH145J : Jaune

CH045 / CH145M2 : Taupe

© Modèle déposé (Réf. INPI : 20205317/20234015)

## UK BAR STOOL

Material: Fabric and polyurethane  
Composition : Fabric :100% polyester - Martindale: 25 000 - Light fastness : > 4  
PU composition : 100% polyurethane - Martindale : 30 000  
Foam density : 25 kgs/m<sup>3</sup>  
Legs : Black lacquered steel

### VEGAS

CH045 : Dimensions : L43 x P45 x H100 cm Seat Height : 65 cm Net Weight : 7,2 kgs  
CH047 : Dimensions : L43 x P45 x H110 cm Seat Height : 75 cm Net Weight : 7,6 kgs

### SAN FRANCISCO

CH145 : Dimensions : L45 x P45 x H100 cm Seat Height : 65 cm Net Weight : 8,35 kgs  
CH147 : Dimensions : L45 x P45 x H110 cm Seat Height : 75 cm Net Weight : 8,75 kgs

Seat pivots 90 ° with return

CH045 / CH145G1 : Grey

CH045 / CH145G2 : Charcoal

CH045 / CH145J : Yellow

CH045 / CH145M2 : Taupe

© Registered design (INPI : 20205317/20234015)

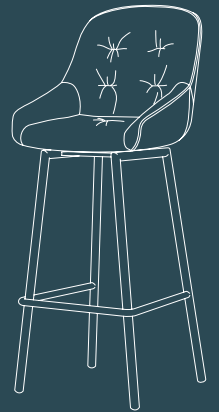

CH145/CH147

## DE BARHOCKER

Material: Stoff und Kunstleder  
Zusammensetzung: Stoff: 100% Polyester - Martindale: 25 000 - Lichtechtheit: > 4  
Kunstleder: 100% Polyurethan - Martindale: 30 000  
Schaumdichte: 25 kg/m<sup>3</sup>  
Fußgestell: Stahl schwarz lackiert

### VEGAS

CH045: Abmessung: L43 x P45 x H100 cm Sitzhöhe: 65 cm Nettogewicht: 7,2 kg  
CH047: Abmessung: L43 x P45 x H110 cm Sitzhöhe: 75 cm Nettogewicht: 7,6 kg

### SAN FRANCISCO

CH145: Abmessung: L45 x P45 x H100 cm Sitzhöhe: 65 cm Nettogewicht: 8,35 kg  
CH147: Abmessung: L45 x P45 x H110 cm Sitzhöhe: 75 cm Nettogewicht: 8,75 kg

Sitzfläche um 90° drehbar / dreht sich automatisch wieder zurück

CH045 / CH145G1: Grau

CH045 / CH145G2: Anthrazit

CH045 / CH145J: Gelb

CH045 / CH145M2: Taupe

© Registriertes Modell (INPI : 20205317/20234015)



**LUMINAIRES**  
*LIGHTING*  
**LEUCHTEN**

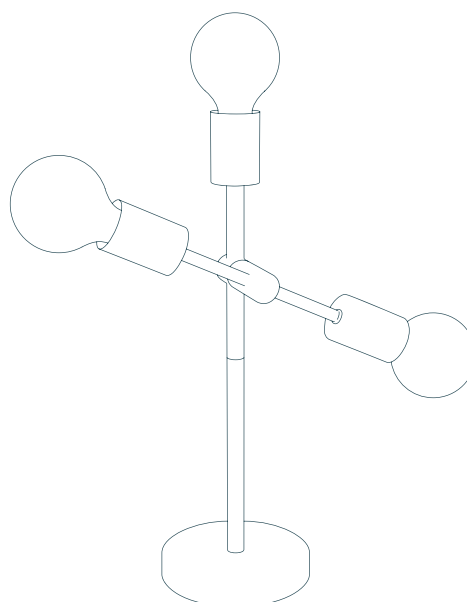

LUMINAIRES  
LIGHTING  
LEUCHTEN

# AKANTE®

ANTALIA





# ANTALIA

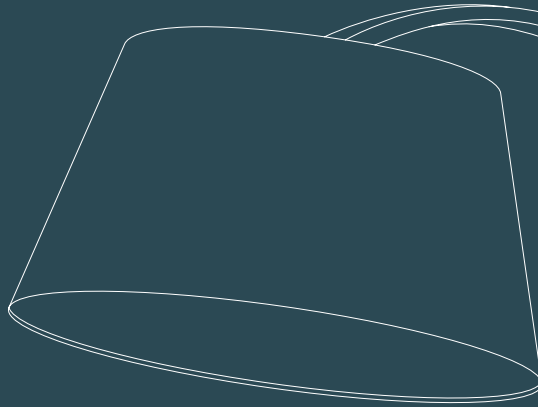

 LAMPADAIRE LA001

Dimensions : 120 x 50 x h195 cm  
Poids Net : 8,4 kg

Abat-jour pivotant  
Pied béton

LA001B1 : Abat-jour en tissu noir - Structure en acier laqué noir  
LA001G1 : Abat-jour en tissu gris - Structure en acier laqué gris

 FLOOR LAMPE LA001

Dimensions : 120 x 50 x H195 cm  
Net weight : 8,4 kgs

Movable shade  
Concrete base

LA001B1 : Black fabric shade - Black lacquered structure  
LA001G1 : Grey fabric shade - Grey lacquered structure

 STEHLEUCHTE LA001

Abmessung: 120 x 50 x H195 cm  
Nettogewicht: 8,4 kg

Schwenkbarer Lampenschirm  
Beton-Fußplatte

LA001B1: Lampenschirm aus schwarzem Stoff - Gestell Stahl schwarz lackiert  
LA001G1: Lampenschirm aus grauem Stoff - Gestell Stahl grau lackiert

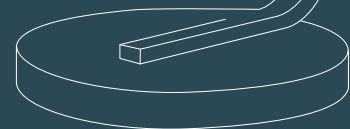

# AKANTE®

ATRIA®



# ATRIA<sup>®</sup>

## LAMPE DE TABLE

LA055

Structure et base en acier laqué noir

Dimensions : L53 x P17,5 x h46,1 cm

Poids Net : 3.5 kg

## LAMPADAIRE

LA060

Dimensions : 93 x 93 x h142,5/160 cm

Poids Net : 8 kg

Ampoules incluses :

LA110 : G80 / 80\*120MM / E27/40W / 220-240V

© Modèle déposé (Réf. INPI : 20200911)

## TABLE LAMP

LA055

Base and structure in epoxy painted steel

Dimensions : L53 x P17,5 x H46,1 cm

Net Weight : 3.5 kgs

## FLOOR LAMP

LA060

Dimensions : 93 x 93 x H142,5/160 cm

Net Weight : 8 kgs

Bulb included :

LA110 : G80 / 80\*120MM / E27/40W / 220-240V

© Registered design (INPI : 20200911)

## TISCHLEUCHTE

LA055

Struktur und Gestell aus schwarz lackiertem Stahl

Abmessung: L53 x P17,5 x H46,1 cm

Nettogewicht: 3.5 kg

## STEHLEUCHTE

LA060

Abmessung: 93 x 93 x H142,5/160 cm

Nettogewicht: 8 kg

Leuchtmittel im Lieferumfang:

LA110: G80 / 80\*120MM / E27/40W / 220-240V

© Registriertes Modell (INPI 20200911)

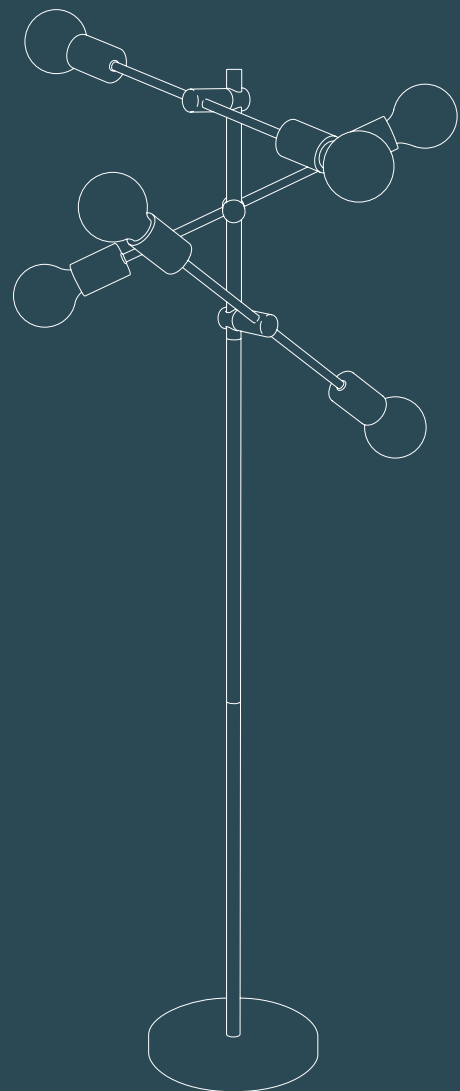

LA060

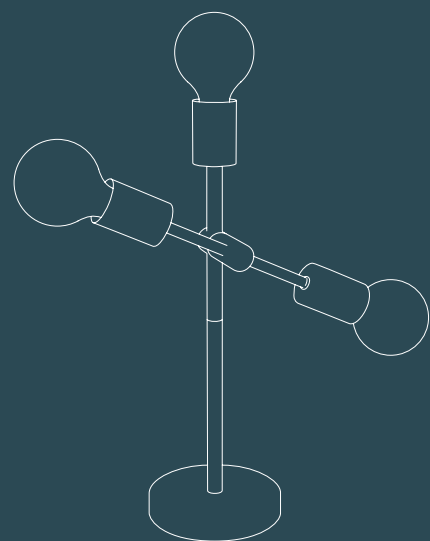

LA055

# AKANTE®

EXPAND



# EXPAND



## LUMINAIRES

Abat-jour en tissu noir pivotant de haut en bas  
Pied béton - Structure en acier laqué noir

LAMPADAIRE LA041B1

Dimensions : L150 x P55 x h178 cm - Poids Net : 11,0 kg

## LIGHTING

Black fabric shade pivoting up and down  
Concrete base - Black lacquered structure

FLOOR LAMP LA041B1

Dimensions : L150 x P55 x H178 cm - Net Weight : 11,0 kgs

LA041B1

## LEUCHTEN

Lampenschirm schwenkbar aus schwarzem Stoff  
Betonfuß - Gestell schwarz lackiert

STEHLAMPE LA041B1

Abmessung: L150 x B55 x H178 cm - Nettogewicht: 11,0 kg

# AKANTE®

GEMINI



# GEMINI

## LAMPE DE TABLE

LA070

Structure en acier laqué noir  
Abat-jour en verre

Dimension : Ø 22 x h50 cm  
Poids Net : 2,5 kg  
Ampoules incluses

## LAMPADAIRE

LA075

Dimension : Ø 30 x h90 cm  
Poids Net : 4 kg  
Ampoules incluses

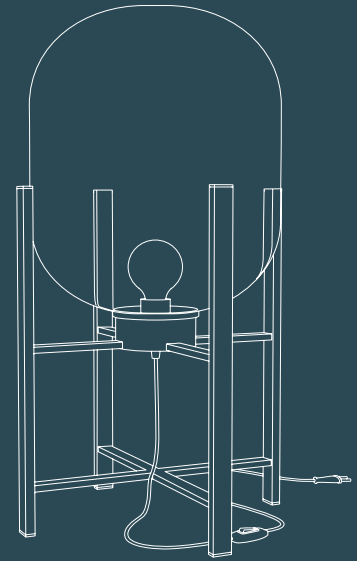

LA070

## TABLE LAMP

LA070

Structure in black epoxy painted steel  
Glass shade

Dimensions : Ø 22 x H50 cm  
Net Weight : 2,5 kgs  
Bulb included

## FLOOR LAMP

LA075

Dimensions : Ø 30 x H90 cm  
Net Weight : 4 kgs  
Bulb included

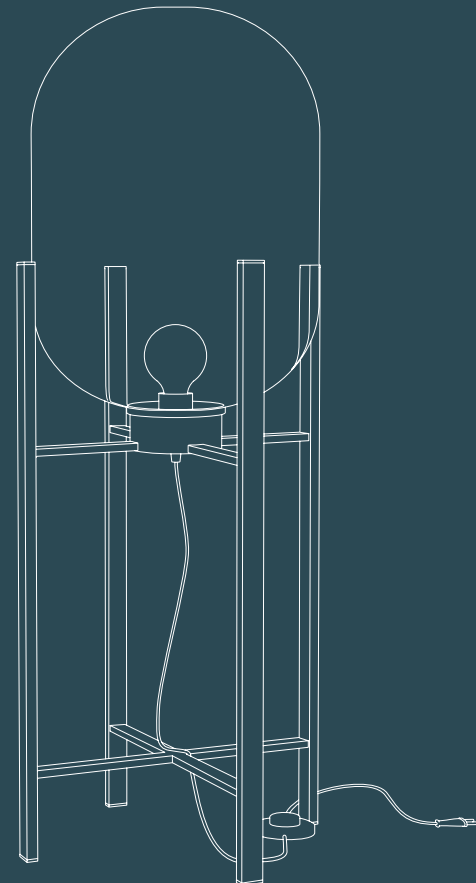

LA075

## TISCHLEUCHTE

LA070

Struktur und Gestell aus schwarz lackiertem Stahl  
Lampenschirm aus Glas

Abmessung: Ø 22 x H50 cm  
Nettogewicht: 2,5 kg  
Glühbirne inklusive

## STEHLEUCHTE

LA075

Abmessung: Ø 30 x H90 cm  
Nettogewicht: 4 kg  
Glühbirne inklusive

# AKANTE®

ORION





# ORION

 LAMPADAIRE LA021B1

Abat-jour en tissu noir pivotant de haut en bas  
Pied béton  
Structure en acier laqué noir  
Dimensions : L50 x P50 x h163 cm  
Poids Net : 8 kg

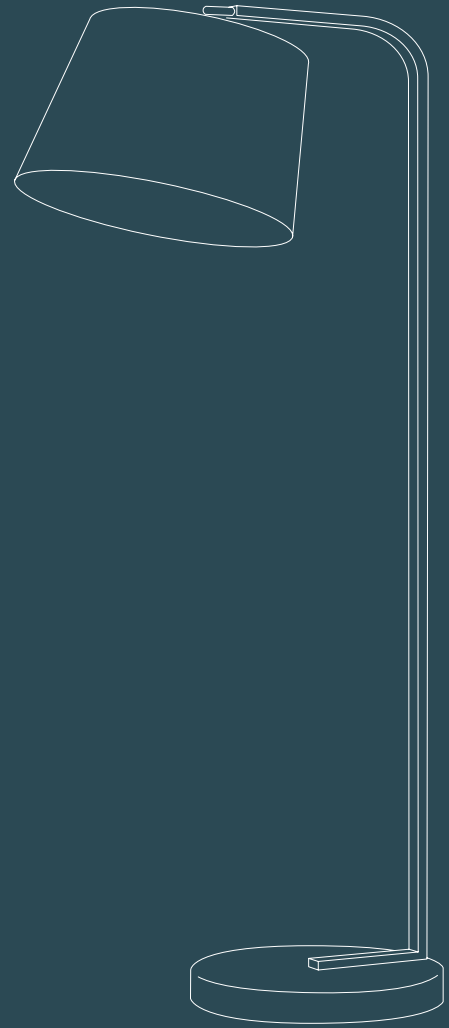

LA021B1

 FLOOR LAMP LA021B1

Concrete base  
Black lacquered structure  
Black fabric shade pivoting up and down  
Dimensions : L50 x P50 x H163 cm  
Net Weight : 8 kgs

 STEHLEUCHTE LA021B1

Lampenschirm aus schwarzem Stoff, nach  
oben und unten schwenkbar  
Betonsockel  
Gestell: Stahl schwarz lackiert  
Abmessung: L50 x P50 x H163 cm  
Nettogewicht: 8 kg

# AKANTE®

SOLARIS



# SOLARIS

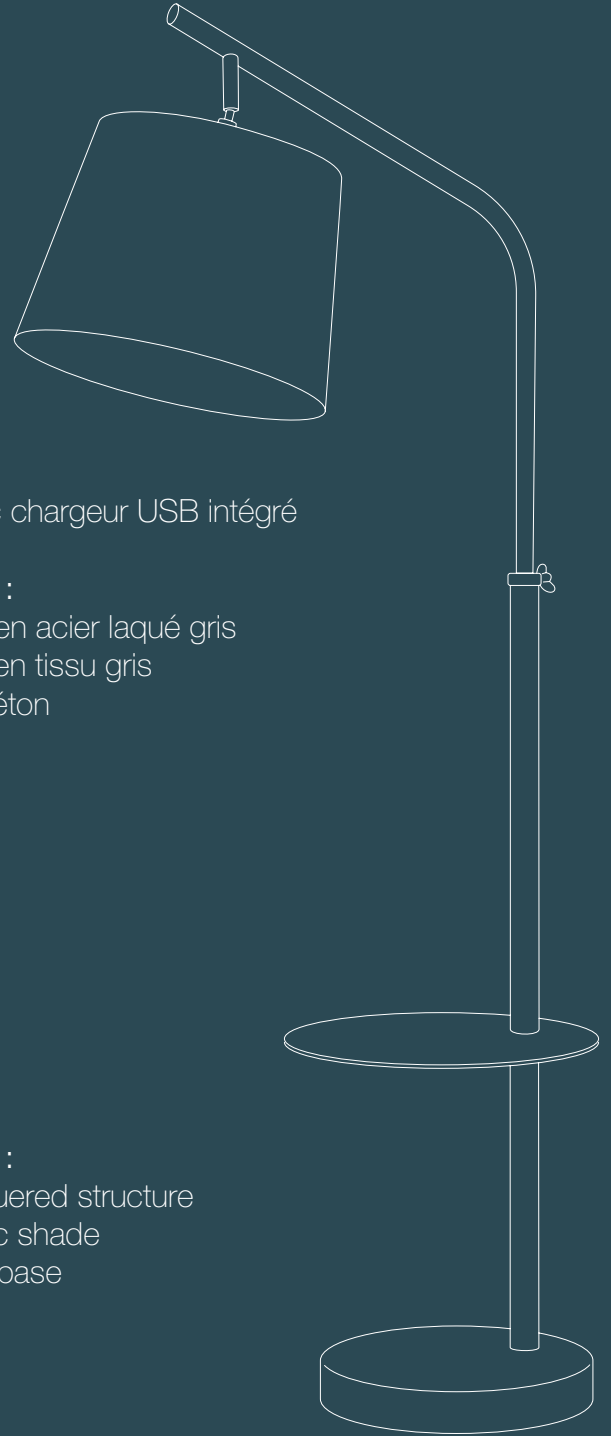

 LAMPADAIRE LA031

Dimensions : L80 x P36 x h170 cm

Poids Net: 11,8 kg

Abat-jour ajustable en hauteur, pivotant de haut en bas  
et possibilité de rotation à 360°

Tablette modulable (rotation 360° sur un plan horizontal) avec chargeur USB intégré

**LA031B1 :**

Structure en acier laqué noir

Abat-jour en tissu noir

Pied en béton

**LA031G1 :**

Structure en acier laqué gris

Abat-jour en tissu gris

Pied en béton

 FLOOR LAMP LA031

Dimensions : L80 x D36 x H170 cm

Net Weight : 11,8 kgs

Movable shade adjustable in height via the pole

Shelf rotating 360° with integrated USB charger

**LA031B1 :**

Black lacquered structure

Black fabric shade

Concrete base

**LA031G1 :**

Grey lacquered structure

Grey fabric shade

Concrete base

 STEHLAMPE LA031

Abmessung: 80 x 36 x h170 cm

Nettogewicht: 11,8 kg

Höhenverstellbarer Lampenschirm, nach oben und unten schwenkbar und um 360° drehbar

Ablageplatte um 360° drehbar mit integrierter USB Ladestation

**LA031B1**

Gestell: Stahl schwarz lackiert

Lampenschirm: schwarzer Stoff

Betonsockel

**LA031G1:**

Grey lacquered structure

Grey fabric shade

Concrete base

  
AKANTE®



**DIVERS**

*MISCELLANEOUS*

**SONSTIGES**

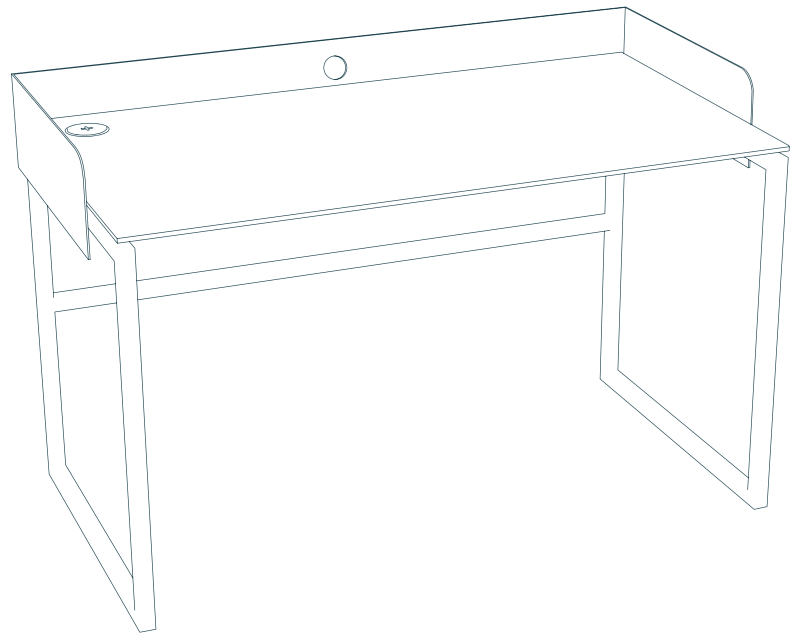

DIVERS  
MISCELLANEOUS  
SONSTIGES



[www.akante.com](http://www.akante.com)

# AKANTE®

BOSTON®



# BOSTON<sup>®</sup>

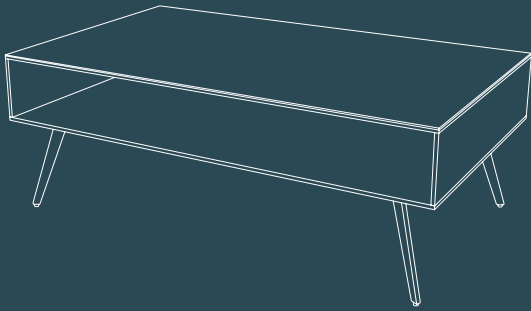

 Plateau supérieur en céramique acier de 3 mm collée sur un verre de 8 mm.  
Caisson en verre gris fumé de 10 mm. Piètement en acier laqué noir mat (équipé de patins réglables).

**TABLE BASSE**      **CT050SD**  
Dimensions : 110 x 65 x h40 cm

Poids Net : 45 kg

**CONSOLE**      **ST050SD**  
Dimensions : 90 x 30 x h75 cm

Poids Net : 25 kg

**BUREAU**      **BU050SD**  
Dimensions : 120 x 60 x h75 cm

Poids Net : 47 kg

© Modèle déposé (Réf. INPI : 20173908)

 Top in 3 mm steel dark ceramic glued on a 8 mm thick glass.  
10 mm smoked grey glass body. Legs in matt black lacquered steel (with built-in levellers).

**COFFEE TABLE**      **CT050SD**  
Dimensions : 110 x 65 x H40 cm

Net Weight : 45 kgs

**CONSOLE**      **ST050SD**  
Dimensions : 90 x 30 x H75 cm

Net Weight : 25 kgs

**DESK**      **BU050SD**  
Dimensions : 120 x 60 x H75 cm

Net Weight : 47 kgs

© Registered design (INPI : 20173908)

 Oberplatte aus 3 mm Keramik in Rostbraun auf 8 mm Glas.  
Korpus aus 10 mm grau getöntem Glas - Füße aus schwarz lackiertem Stahl (mit plastikkappe).

**COUCHTISCH**      **CT050SD**  
Abmessung: 110 x 65 x H40 cm

Nettogewicht: 45 kg

**KONSOLE**      **ST050SD**  
Abmessung: 90 x 30 x H75 cm

Nettogewicht: 25 kg

**SCHREIBTISCH**      **BU050SD**  
Abmessung: 120 x 60 x H75 cm

Nettogewicht: 47 kg

© Registriertes Modell (INPI 20173908)

# AKANTE®

CUBA®



# CUBA®

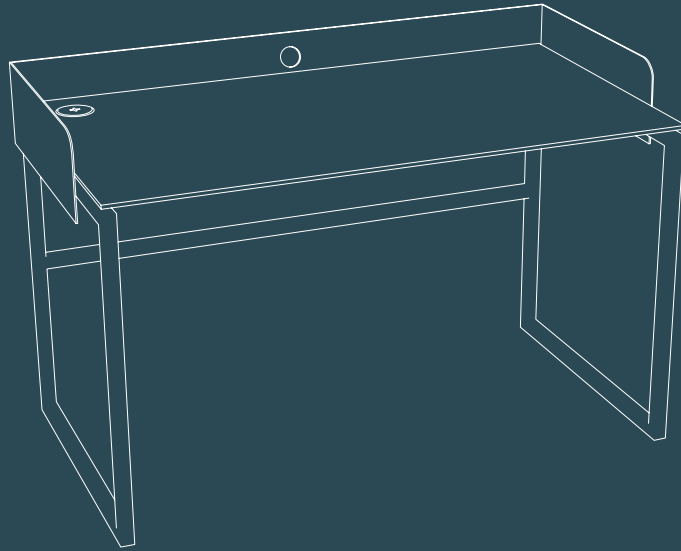

BUREAU

BU060

Plateau supérieur en céramique de 3 mm collée sur un verre de 8 mm  
Cadre et piètement en acier laqué noir mat

BU060TI / SI : Plateau supérieur en céramique titane / silver

BU061TI / SI : Plateau supérieur en céramique titane / silver avec un chargeur à induction intégré

Dimensions : 130 x 70 x h73,5 cm

Poids Net : 38 kg

© Modèle déposé (Réf. INPI : 20215513)



DESK

BU060

Top in 3 mm steel dark ceramic glued on a 8 mm thick glass  
Structure and legs in matt black lacquered steel

BU060TI / SI : Ceramic top plate titanium / silver

BU061TI / SI : Ceramic top plate titanium / silver with a built-in Qi charger

Dimensions : 130 x 70 x H73,5 cm

Net Weight : 38 kgs

© Registered design (INPI : 20215513)



SCHREIBTISCH

BU060

3 mm Keramikplatte auf 8 mm starkem Glas  
Umrandung und Gestell aus schwarz matt lackiertem Stahl

BU060TI / SI: Keramikplatte Titan / silver

BU061TI / SI: Keramikplatte Titan / silver mit eingebautem Qi-Ladegerät

Abmessung: 130 x 70 x H73,5 cm

Nettogewicht: 38 kg

© Registriertes Modell (INPI 20215513)



# AKANTE®

FALCON®



# FALCON®



BUREAU

BU064 / BU065

Plateau supérieur en céramique acier de 3 mm collée sur un verre de 8 mm  
Cadre et piètement en acier laqué noir mat.

BU064TI / SI : Plateau supérieur en céramique titane / silver

BU065TI / SI : Plateau supérieur en céramique titane / silver avec un chargeur à induction intégré

Dimensions : 130 x 70 x h73,5 cm

Poids Net : 42 kg

© Modèle déposé (Réf. INPI : 20222320)



DESK

BU064 / BU065

Top in 3 mm steel dark ceramic glued on a 8 mm thick glass  
Structure and legs in matt black lacquered steel.

BU064TI / SI : Ceramic top plate titanium / silver

BU065TI / SI : Ceramic top plate titanium / silver with a built-in Qi charger

Dimensions : 130 x 70 x H73,5 cm

Net Weight : 42 kgs

© Registered design (INPI : 20222320)



SCHREIBTISCH

BU064 / BU065

Oberplatte aus 3 mm Keramik in rostbraun auf 8 mm starkem Glas.  
Umrandung und Gestell aus schwarz matt lackiertem Stahl.

BU064TI / SI: Keramikplatte Titan / silver

BU065TI / SI: Keramikplatte Titan / silver mit eingebautem Qi-Ladegerät

Abmessung: 130 x 70 x H73,5 cm

Nettogewicht: 42 kg

© Registriertes Modell (INPI : 20222320)

# AKANTE®

MURANO®



# MURANO®

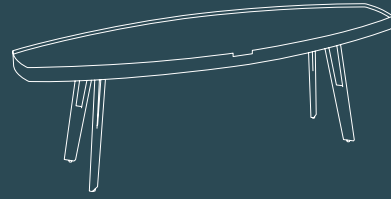
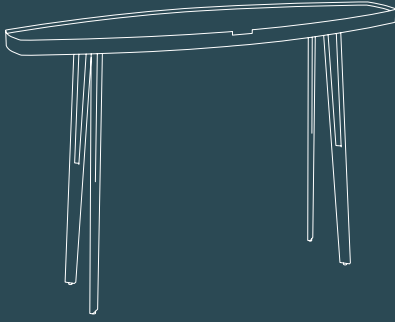

## 🇫🇷 CONSOLE

Piètement : Pieds ajourés en acier laqué noir mat

Dimensions : 120 x 40 x h80 cm  
Poids Net : 24 kg

### ST120MC :

Plateau céramique pleine masse de 11 mm,  
couleur Calcatta (MC)  
Ceinture acier effet laiton de 4 cm de hauteur

### ST120MM :

Plateau céramique pleine masse de 11 mm,  
couleur Marquina (MM)  
Ceinture acier laqué noir de 4 cm de hauteur

## MEUBLE TV

Piètement : Pieds ajourés en acier laqué noir mat

Dimensions : 120 x 40 x h38 cm  
Poids Net : 20 kg

### TV120MC :

Plateau céramique pleine masse de 11 mm,  
couleur Calcatta (MC)  
Ceinture acier effet laiton de 4 cm de hauteur

### TV120MM :

Plateau céramique pleine masse de 11 mm,  
couleur Marquina (MM)  
Ceinture acier laqué noir de 4 cm de hauteur

© Modèle déposé (Réf. INPI : 20222320)

## 🇬🇧 CONSOLE TABLE

Legs : Open-style legs black lacquered steel

Dimensions : 120 x 40 x H80 cm  
Net weight : 24 kgs

### ST120MC :

Full body ceramic thickness 11 mm,  
colour Calcatta (MC)  
Steel frame with brass effect, Height 4 cm

### ST120MM :

Full body ceramic thickness 11 mm,  
colour Marquina (MM)  
Steel frame black lacquered steel, Height 4 cm

## TV SET

Legs : Open-style legs black lacquered steel

Dimensions : 120 x 40 x H38 cm  
Net weight : 20 kgs

### TV120MC :

Full body ceramic thickness 11 mm,  
colour Calcatta (MC)  
Steel frame with brass effect, Height 4 cm

### TV120MM :

Full body ceramic thickness 11 mm,  
colour Marquina (MM)  
Steel frame black lacquered steel, Height 4 cm

© Registered design (INPI : 20222320)

## 🇩🇪 KONSOLE

Gestell: durchbrochen Stahl schwarz matt lackiert

Abmessung: 120 x 40 x H80 cm  
Nettogewicht: 24 kg

### ST120MC:

11 mm dicke Vollkeramik, farbe Calcatta (MC)  
Messingfarbener Stahlgürtel mit 4 cm Höhe

### ST120MM:

11 mm dicke Vollkeramik, farbe Marquina (MM)  
Schwarz lackierter Stahl mit 4 cm Höhe

## TV-MEDIAMÖBEL

Gestell: durchbrochen Stahl schwarz matt lackiert

Abmessung: 120 x 40 x H38 cm  
Nettogewicht: 20 kg

### TV120MC:

11 mm dicke Vollkeramik, farbe Calcatta (MC)  
Messingfarbener Stahlgürtel mit 4 cm Höhe

### TV120MM:

11 mm dicke Vollkeramik, farbe Marquina (MM)  
Schwarz lackierter Stahl mit 4 cm Höhe

© Registriertes Modell (INPI : 20222320)

# AKANTE®

RAFALE®



# RAFALE<sup>®</sup>

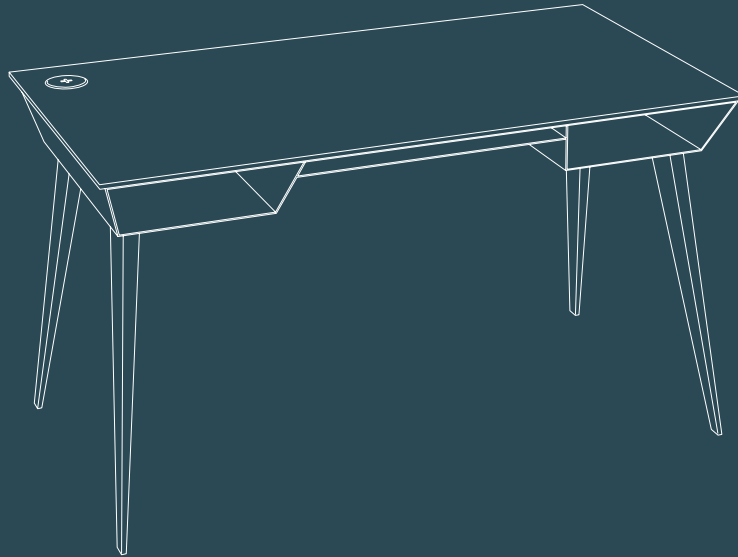

BUREAU

BU062 / BU063

Plateau supérieur en céramique acier de 3 mm collée sur un verre de 8 mm  
Caisson de rangement et piètement en acier laqué noir mat

BU062TI / SI : Plateau supérieur en céramique titane / silver

BU063TI / SI : Plateau supérieur en céramique titane / silver avec un chargeur à induction intégré

Dimensions : 130 x 70 x h73,5 cm

Poids Net : 56 kg

© Modèle déposé (Réf. INPI : 20215513)



DESK

BU062 / BU063

Top in 3 mm steel dark ceramic glued on a 8 mm thick glass  
Body and legs in matt black lacquered steel

BU062TI / SI : ceramic top plate titanium / silver

BU063TI / SI : ceramic top plate titanium / silver with a built-in Qi charger

Dimensions : 130 x 70 x H73,5 cm

Net Weight : 56 kgs

© Registered design (INPI : 20215513)



SCHREIBTISCH

BU062 / BU063

Oberplatte aus 3 mm Keramik in rostbraun auf 8 mm starkem Glas  
Ablageplatten und Gestell aus schwarz matt lackiertem Stahl

BU062TI / SI: Keramikplatte Titan / silver

BU063TI / SI: Keramikplatte Titan / silver mit eingebautem Qi-Ladegerät

Abmessung: 130 x 70 x H73,5 cm

Nettogewicht: 56 kg

© Registriertes Modell (INPI 20215513)

# AKANTE®

VERSAILLES®



# VERSAILLES<sup>®</sup>

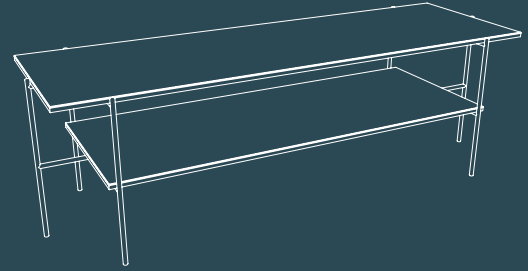
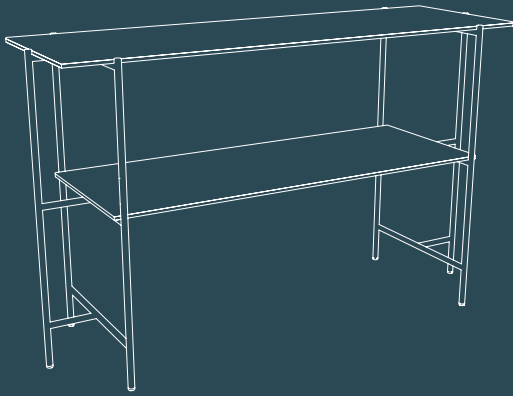

## CONSOLE ST210

Plateaux : Céramique de 3 mm collée sur un verre de 6 mm d'épaisseur

Couleurs : Acier (SD), Argile (AR), Chêne clair (CC), Marbre mat (MA), Silver (SI), Titane (TI)

Piètement : Pieds en acier laqué noir mat

Dimensions : 123 x 41 x h75 cm  
Poids Net : 24 kg

## MEUBLE TV TV210

Plateaux : Céramique de 3 mm collée sur un verre de 6 mm d'épaisseur

Couleurs : Acier (SD), Argile (AR), Chêne clair (CC), Marbre mat (MA), Silver (SI), Titane (TI)

Piètement : Pieds en acier laqué noir mat

Dimensions : 123 x 41 x h38 cm  
Poids Net : 22,5 kg

© Modèles déposés (Réf. INPI : 20231433)

## CONSOLE TABLE ST210

Plates : Ceramic over glass thickness 3 + 6 mm

Colours : Steel dark (SD), Argile (AR), Clear oak (CC), Matt marble (MA), Silver (SI), Titanium (TI)

Legs : matt black lacquered steel

Dimensions : 123 x 41 x H75 cm  
Net weight : 24 kgs

## TV SET TV210

Plates : Ceramic over glass thickness 3 + 6 mm

Colours : Steel dark (SD), Argile (AR), Clear oak (CC), Matt marble (MA), Silver (SI), Titanium (TI)

Legs : matt black lacquered steel

Dimensions : 123 x 41 x H38 cm  
Net weight : 22,5 kgs

© Registered design (Réf INPI : 20231433)

## KONSOLE ST210

Tischplatte: Keramik auf Glas 3+6 mm

Farben: rostbraun (SD), zementgrau (AR), eiche hell (CC), Marmoroptik matt (MA), silver (SI), Titan (TI)

Gestell: Schwartz lackieren Stahl

Abmessung: 123 x 41 x H75 cm  
Nettogewicht: 24 kg

## TV-MEDIAMÖBEL ST210

Tischplatte: Keramik auf Glas 3+6 mm

Farben: rostbraun (SD), zementgrau (AR), eiche hell (CC), Marmoroptik matt (MA), silver (SI), Titan (TI)

Gestell: Schwartz lackieren Stahl

Abmessung: 123 x 41 x H38 cm  
Nettogewicht: 22,5 kg

© Registriertes Modell (INPI 20231433)



  
AKANTE®



**EXTÉRIEUR**  
*OUTDOOR*  
**OUTDOOR**

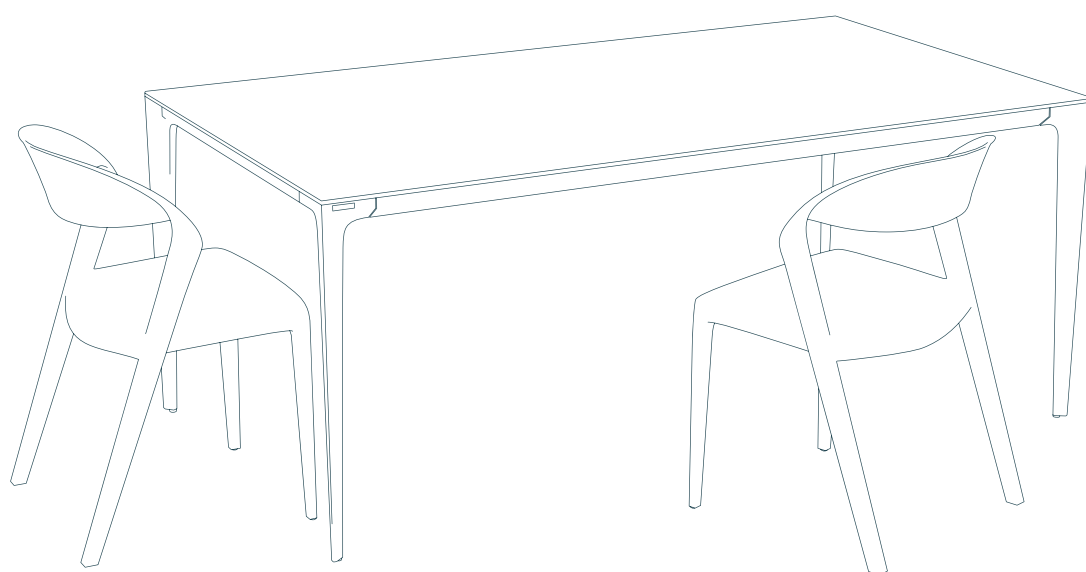

[www.akante.com](http://www.akante.com)

EXTÉRIEUR  
OUTDOOR

# AKANTE®

GALET OUTDOOR®



# GALET OUTDOOR<sup>®</sup>

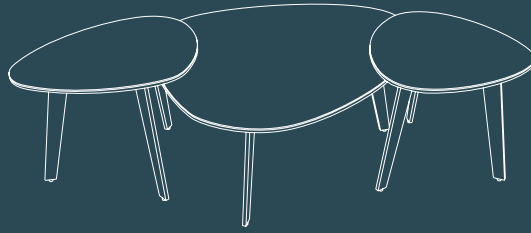

Plateau supérieur :

Céramique de 3 mm collée sur un verre de 6 mm d'épaisseur, couleurs : Argile (AR), Marbre Mat (MA), Acier (SD), Silver (SI), Titane (TI)

Céramique pleine masse de 11 mm, couleurs : Marquina (MM), Calcatta (MC), Onyx bleu (MO)

Piètement : Aluminium laqué blanc et Anthracite

## TABLE BASSE

Dimensions : 92 x 76 x h33 cm  
h38 cm  
h43 cm  
h50 cm

Poids Net : 15 kg

## COIN CANAPÉ

Dimensions : 55 x 45 x h33 cm  
h38 cm  
h43 cm  
h50 cm

Poids Net : 7 kg

© Modèle déposé (Réf. INPI : 20190743)



Top plate :

Ceramic over glass thickness 3 + 6 mm, colours : Argile (AR), Matt marble (MA), Steel dark (SD), Silver (SI), Titanium (TI)

Full body ceramic thickness 11 mm, colours : Marquina (MM), Calcatta (MC), Onyx blue (MO)

Legs : White lacquered Aluminium and Anthracite grey

## COFFEE TABLE

Dimensions : 92 x 76 x H33 cm  
H38 cm  
H43 cm  
H50 cm

Net weight : 15 kgs

## END TABLE

Dimensions : 55 x 45 x H33 cm  
H38 cm  
H43 cm  
H50 cm

Net weight : 7 kgs

© Registered design (INPI : 20190743)



Tischplatte:

Keramik auf Glas Stärke 3 + 6 mm, farben: zementgrau (AR), Marmoroptik matt (MA), rostbraun (SD), silver (SI), Titan (TI)

11 mm dicke Vollkeramik, farben: Marquina (MM), Calcatta (MC), Onyx blau (MO)

Gestell: Aluminium weiße oder Anthrazitgrau

## COUCHTISCH

Abmessung: 92 x 76 x H33 cm  
H38 cm  
H43 cm  
H50 cm

Nettogewicht: 15 kg

## BEISTELLTISCH

Abmessung: 55 x 45 x H33 cm  
H38 cm  
H43 cm  
H50 cm

Nettogewicht: 7 kg

© Registriertes Modell (INPI : 20190743)

# AKANTE®

GALICE OUTDOOR®



# GALICE OUTDOOR®

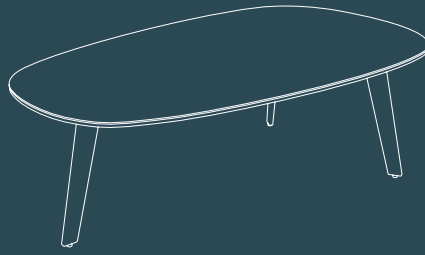

Plateau supérieur :

Céramique de 3 mm collée sur un verre de 6 mm d'épaisseur, couleurs : Argile (AR), Marbre Mat (MA), Acier (SD), Silver (SI), Titane (TI), Chêne clair (CC)

Céramique pleine masse de 11 mm, couleurs : Marquina (MM), Calcatta (MC), Onyx bleu (MO)

Piètement : Aluminium laqué blanc

## TABLE BASSE

Dimensions : 100 x 60 x h33cm  
h38 cm  
h43 cm  
h50 cm

Poids Net : 15 kg

© Modèle déposé (Réf. INPI : 20190743)



Top plate :

Ceramic over glass thickness 3 + 6 mm, colours : Argile (AR), Matt marble (MA), Steel dark (SD), Silver (SI), Titanium (TI), Clear oak (CC)

Full body ceramic thickness 11 mm, colours : Marquina (MM), Calcatta (MC), Onyx blue (MO)

Legs : White lacquered Aluminium

## COFFEE TABLE

Dimensions : 100 x 60 x H33 cm  
H38 cm  
H43 cm  
H50 cm

Net weight : 15 kgs

© Registered design (INPI : 20190743)



Tischplatte:

Keramik auf Glas Stärke 3 + 6 mm, farben: zementgrau (AR), Marmoroptik matt (MA), rostbraun (SD), silver (SI), Titan (TI), eiche hell (CC)

11 mm dicke Vollkeramik, farben: Marquina (MM), Calcatta (MC), Onyx blau (MO)

Gestell: Aluminium weiße

## COUCHTISCH

Abmessung: 100 x 60 x H33 cm  
H38 cm  
H43 cm  
H50 cm

Nettogewicht: 15 kg

© Registriertes Modell (INPI : 20190743)

# AKANTE®

SILVERSTONE OUTDOOR®



# SILVERSTONE OUTDOOR®



Plateau supérieur :

Céramique de 3 mm collée sur un verre de 6 mm d'épaisseur, couleurs : Argile (AR), Marbre Mat (MA), Acier (SD), Silver (SI), Titane (TI), Chêne clair (CC)

Céramique pleine masse de 11 mm, couleurs : Marquina (MM), Calcatta (MC), Onyx bleu (MO)

Piètement : Aluminium laqué blanc

## TABLE BASSE

Pieds pleins : CT930 / CT931 / CT932 / CT933

Dimensions : 100 x 60 x h33 cm

h38 cm

h43 cm

h50 cm

Poids Net : 15 kg

## COIN CANAPÉ

Pieds pleins : ET930 / ET931 / ET932 / ET933

Dimensions : 60 x 36 x h33 cm

h38 cm

h43 cm

h50 cm

Poids Net : 6,5 kg

© Modèle déposé à l'INPI



Top plate :

Ceramic over glass thickness 3 + 6 mm, colours : Argile (AR), Matt marble (MA), Steel dark (SD), Silver (SI), Titanium (TI), Clear oak (CC)

Full body ceramic thickness 11 mm, colours : Marquina (MM), Calcatta (MC), Onyx blue (MO)

Legs : White lacquered Aluminium

## COFFEE TABLE

Solid legs : CT930 / CT931 / CT932 / CT933

Dimensions : 100 x 60 x H33 cm

H38 cm

H43 cm

H50 cm

Net weight : 15 kgs

## END TABLE

Solid legs : ET930 / ET931 / ET932 / ET933

Dimensions : 60 x 36 x H33 cm

H38 cm

H43 cm

H50 cm

Net weight : 6,5 kgs

© Registered design INPI



Tischplatte:

Keramik auf Glas Stärke 3 + 6 mm, farben: zementgrau (AR), Marmoroptik matt (MA), rostbraun (SD), silver (SI), Titan (TI), eiche hell (CC)

11 mm dicke Vollkeramik, farben: Marquina (MM), Calcatta (MC), Onyx blau (MO)

Gestell: Aluminium weiße

## COUCHTISCH

Tischbeine ganz : CT930 / CT931 / CT932 / CT933

Abmessung: 100 x 60 x H33 cm

H38 cm

H43 cm

H50 cm

Nettogewicht: 15 kg

## BEISTELLTISCH

Tischbeine ganz: ET930 / ET931 / ET932 / ET933

Abmessung: 60 x 36 x H33 cm

H38 cm

H43 cm

H50 cm

Nettogewicht: 6,5 kg

© Registriertes Modell INPI

# AKANTE®

TOSCA RONDE OUTDOOR





# TOSCA RONDE OUTDOOR

🇫🇷 Plateau supérieur :  
Céramique de 3 mm collée sur un verre de 6 mm d'épaisseur,  
couleurs :  
Argile (AR), Marbre Mat (MA), Acier (SD), Silver (SI), Titane (TI),  
Chêne clair (CC)  
Céramique pleine masse de 11 mm, couleurs : Marquina (MM),  
Calcatta (MC), Onyx bleu (MO)

Piètement : Aluminium laqué blanc ou Anthracite



## TABLE BASSE

Pieds pleins : CT907 / CT908 / CT911 / CT929

Dimensions : Ø 70 x h33 cm  
h38 cm  
h43 cm  
h50 cm

Poids Net : 12 kg

## COINS CANAPÉ

Pieds pleins : ET904 / ET905 / ET906 / ET907  
ET908 / ET910 / ET911 / ET929

Dimensions : Ø 50 ou Ø 40 x h33 cm  
h38 cm  
h43 cm  
h50 cm

Poids Net : 7 kg

🇬🇧 Top plate :  
Ceramic over glass thickness 3 + 6 mm, colours : Argile (AR), Matt marble (MA), Steel dark (SD), Silver (SI),  
Titanium (TI), Clear oak (CC)  
Full body ceramic thickness 11 mm, colours : Marquina (MM), Calcatta (MC), Onyx blue (MO)

Legs : White lacquered Aluminium or Anthracite grey

## COFFEE TABLE

Solid legs : CT907 / CT908 / CT911 / CT929

Dimensions : Ø 70 x H33 cm  
H38 cm  
H43 cm  
H50 cm

Net weight : 12 kgs

## END TABLE

Solid legs : ET904 / ET905 / ET906 / ET907  
ET908 / ET910 / ET911 / ET929

Dimensions : Ø 50 ou Ø 40 x H33 cm  
H38 cm  
H43 cm  
H50 cm

Net weight : 7 kgs

🇩🇪 Tischplatte:  
Keramik auf Glas Stärke 3 + 6 mm, farben: zementgrau (AR), Marmoroptik matt (MA), rostbraun (SD), silver (SI),  
Titan (TI), eiche hell (CC)  
11 mm dicke Vollkeramik, farben: Marquina (MM), Calcatta (MC), Onyx blau (MO)

Gestell: weiß lackiertes Aluminium oder Anthrazitgrau

## COUCHTISCH

Tischbeine ganz: C907 / CT908 / CT911 / CT929

Abmessung: Ø 70 x H33 cm  
H38 cm  
H43 cm  
H50 cm

Nettogewicht: 12 kg

## BEISTELLTISCH

Tischbeine ganz: ET904 / ET905 / ET906 / ET907  
ET908 / ET910 / ET911 / ET929

Abmessung: Ø 50 ou Ø 40 x H33 cm  
H38 cm  
H43 cm  
H50 cm

Nettogewicht: 7 kg

# AKANTE®

MAJORELLE ©

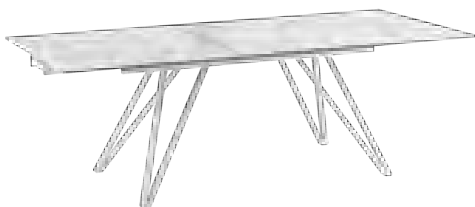
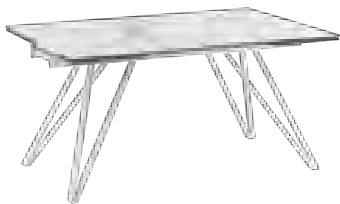

# MAJORELLE<sup>®</sup>

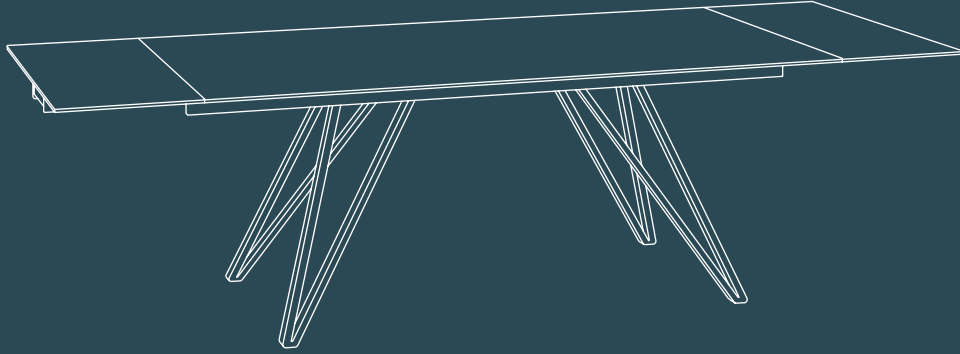

## TABLE DE REPAS

Plateau en céramique de 3 mm collé sur un verre de 8 mm d'épaisseur, couleurs :  
Marbre Mat **(MA)** et Silver **(SI)**  
2 rallonges indépendantes rétractables

DT256 / DT258 : Dimensions : 150/230 x 100 x h76 cm - Poids Net : 87 kg

DT255 / DT257 : Dimensions : 190/270 x 100 x h76 cm - Poids Net : 103 kg

DT257 / DT258 : Piétement en aluminium laqué gris anthracite

DT255 / DT256 : Piétement en aluminium laqué blanc

© Modèle déposé (Réf. INPI : 20231433)

## DINING TABLE

Top : Ceramic over glass 3 + 8 mm, colours : Matt marble **(MA)** or Silver **(SI)**  
Two independant pull-out extensions

DT256 / DT258 : Dimensions : 150/230 x 100 x h76 cm - Net Weight : 87 kgs

DT255 / DT257 : Dimensions : 190/270 x 100 x h76 cm - Net Weight : 103 kgs

DT257 / DT258 : Legs in grey anthracite lacquered aluminium

DT255 / DT256 : Legs in white lacquered aluminium

© Registered design (INPI : 20231433)

## ESSTISCH

Tischplatte: 3 mm Keramik, geklebt auf 8mm Glas, farben: Marmoroptik matt **(MA)** und silver **(SI)**  
2 voneinander unabhängig einziehbare Verlängerungen

DT256 / DT258: Abmessung: 150/230 x 100 x H76 cm - Nettogewicht: 87 kg

DT255 / DT257: Abmessung: 190/270 x 100 x H76 cm - Nettogewicht: 103 kg

DT257 / DT258: Gestell: Anthrazitgrau lackiertes Aluminium

DT255 / DT256: Gestell: weiß lackiertes Aluminium

© Registriertes Modell (INPI: 20231433)

# AKANTE®

MALLORCA®

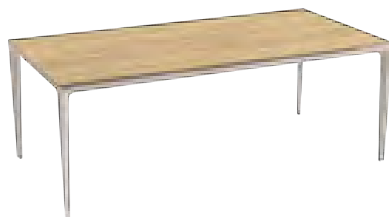
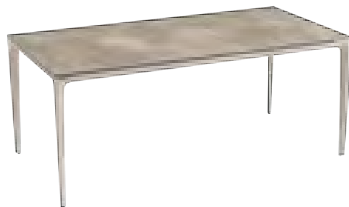

# MALLORCA<sup>®</sup>



## TABLE DE REPAS

## OUTDOOR

Plateau : Céramique de 3 mm collée sur un verre de 8 mm d'épaisseur, couleurs : Argile (AR), Marbre Mat (MA), Acier (SD), Silver (SI), Titane (TI), Chêne Clair (CC)

Céramique pleine masse de 11 mm, couleurs : Marquina (MM), Calcutta (MC)

DT300 / DT305 / DT320 / DT340 : Piètement blanc 100% aluminium

DT302 / DT307 / DT322 : Piètement gris cachemire 100% aluminium

DT350 / DT355 / DT370 / DT390 : Piètement gris anthracite 100% aluminium

DT300 / DT302 / DT350 : Dimensions : 160 x 90 x h74 cm

Poids Net : 55,5 kg

DT305 / DT307 / DT355 : Dimensions : 180 x 90 x h74 cm

Poids Net : 69 kg

DT320 / DT322 / DT370 : Dimensions : 200 x 100 x h74 cm

Poids Net : 71,5 kg

DT340 / DT390 : Dimensions : 240 x 100 x h74 cm

Poids Net : 84,9 kg

© Modèle déposé (Réf. INPI : 20215513)

## DINING TABLE

## OUTDOOR

Top : Ceramic over glass thickness 3 + 8 mm, colours : Argile (AR), Matt marble (MA), Steel dark (SD), Silver (SI), Titanium (TI), Clear Oak (CC)

Full body ceramic thickness 11 mm, colours : Marquina (MM), Calcutta (MC)

DT300 / DT305 / DT320 / DT340 : White legs in 100% Aluminium

DT302 / DT307 / DT322 : Cashmere grey legs in 100% Aluminium

DT350 / DT355 / DT370 / DT390 : Anthracite grey legs 100% Aluminium

DT300 / DT302 / DT350 : Dimensions : 160 x 90 x H74 cm

Net Weight : 55,5 kgs

DT305 / DT307 / DT355 : Dimensions : 180 x 90 x H74 cm

Net Weight : 69 kgs

DT320 / DT322 / DT370 : Dimensions : 200 x 100 x H74 cm

Net Weight : 71,5 kgs

DT340 / DT390 : Dimensions : 240 x 100 x h74 cm

Net Weight : 84,9 kgs

© Registered design (INPI : 20215513)

## ESSTISCH

## OUTDOOR

Keramik auf Glas Stärke 3 + 8 mm, farben: zementgrau (AR), Marmoroptik matt (MA), rostbraun (SD), silver (SI), Titan (TI), Eiche Hell (CC)

11 mm dicke Vollkeramik, farben: Marquina (MM), Calcutta (MC)

DT300 / DT305 / DT320 / DT340: Weiße Füße aus 100% Aluminium

DT302 / DT307 / DT322: Graue Füße aus 100% Aluminium

DT350 / DT355 / DT370 / DT390: Anthrazitgrau Füße aus 100% Aluminium

DT300 / DT302 / DT350: Abmessung: 160 x 90 x H74 cm

Nettogewicht: 55,5 kg

DT305 / DT307 / DT355: Abmessung: 180 x 90 x H74 cm

Nettogewicht: 69 kg

DT320 / DT322 / DT370: Abmessung: 200 x 100 x H74 cm

Nettogewicht: 71,5 kg

DT340 / DT390: Abmessung: 240 x 100 x H74 cm

Nettogewicht: 84,9 kg

# AKANTE®

MALLORCA®

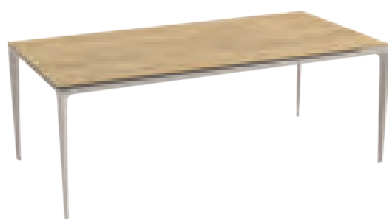
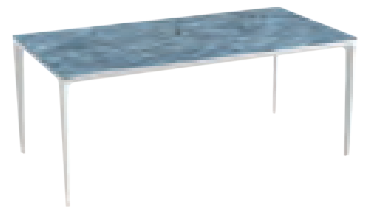
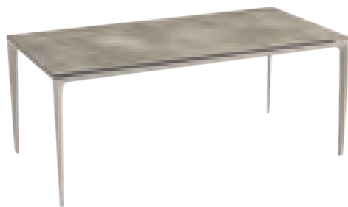
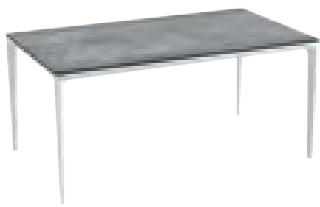

# MALLORCA<sup>®</sup>



## TABLE DE REPAS

## OUTDOOR

Plateau : Céramique de 3 mm collée sur un verre de 8 mm d'épaisseur, couleurs : Argile (AR), Marbre Mat (MA), Acier (SD), Silver (SI), Titane (TI), Chêne Clair (CC)

Céramique pleine masse de 11 mm, couleurs : Marquina (MM), Calcatta (MC), Onyx bleu (MO)

DT300 / DT305 / DT320 / DT340 : Piètement blanc 100% aluminium

DT302 / DT307 / DT322 : Piètement gris cachemire 100% aluminium

DT350 / DT355 / DT370 / DT390 : Piètement gris anthracite 100% aluminium

DT300 / DT302 / DT350 : Dimensions : 160 x 90 x h74 cm

Poids Net : 54 kg

DT305 / DT307 / DT355 : Dimensions : 180 x 90 x h74 cm

Poids Net : 63 kg

DT320 / DT322 / DT370 : Dimensions : 200 x 100 x h74 cm

Poids Net : 68 kg

DT340 / DT370 : Dimensions : 240 x 100 x h74 cm

Poids Net : 75 kg

© Modèle déposé (Réf. INPI : 20215513)

## DINING TABLE

## OUTDOOR

Top : Ceramic over glass thickness 3 + 8 mm, colours : Argile (AR), Matt marble (MA), Steel dark (SD), Silver (SI), Titanium (TI), Clear Oak (CC)

Full body ceramic thickness 11 mm, colours : Marquina (MM), Calcatta (MC), Onyx blue (MO)

DT300 / DT305 / DT320 / DT340 : White legs in 100% Aluminium

DT302 / DT307 / DT322 : Cashmere grey legs in 100% Aluminium

DT350 / DT355 / DT370 / DT390 : Anthracite grey legs 100% Aluminium

DT300 / DT302 / DT350 : Dimensions : 160 x 90 x H74 cm

Net Weight : 54 kgs

DT305 / DT307 / DT355 : Dimensions : 180 x 90 x H74 cm

Net Weight : 63 kgs

DT320 / DT322 / DT370 : Dimensions : 200 x 100 x H74 cm

Net Weight : 68 kgs

DT340 / DT370 : Dimensions : 240 x 100 x h74 cm

Net Weight : 75 kgs

© Registered design (INPI : 20215513)

## ESSTISCH

## OUTDOOR

Keramik auf Glas Stärke 3 + 8 mm, farben: zementgrau (AR), Marmoroptik matt (MA), rostbraun (SD), silver (SI), Titan (TI), Eiche Hell (CC)

11 mm dicke Vollkeramik, farben: Marquina (MM), Calcatta (MC), Onyx blau (MO)

DT300 / DT305 / DT320 / DT340: Weiße Füße aus 100% Aluminium

DT302 / DT307 / DT322: Graue Füße aus 100% Aluminium

DT350 / DT355 / DT370 / DT390 : Anthrazitgrau Füße aus 100% Aluminium

DT300 / DT302 / DT350: Abmessung: 160 x 90 x H74 cm

Nettogewicht: 54 kg

DT305 / DT307 / DT355: Abmessung: 180 x 90 x H74 cm

Nettogewicht: 63 kg

DT320 / DT322 / DT370: Abmessung: 200 x 100 x H74 cm

Nettogewicht: 68 kg

DT340 / DT390: Abmessung: 240 x 100 x H74 cm

Nettogewicht: 75 kg

# AKANTE®

ONTARIO OUTDOOR®

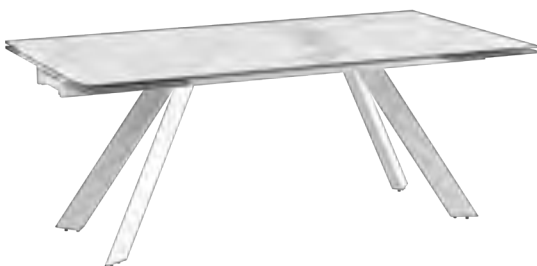



# ONTARIO OUTDOOR®

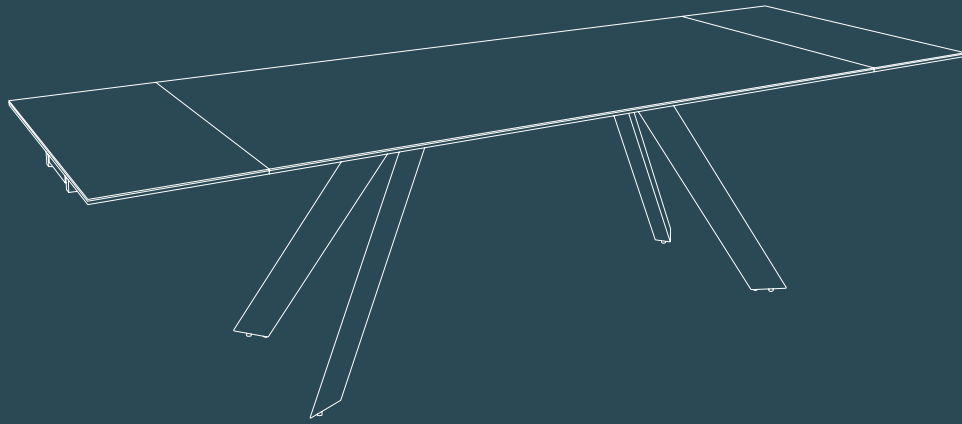

## TABLE DE REPAS

Plateau : Céramique de 3 mm collée sur un verre de 8 mm d'épaisseur, couleurs : Marbre Mat **(MA)** et Silver **(SI)**

2 rallonges indépendantes rétractables

DT248 / DT246 : Dimensions : 150/230 x 100 x h76 cm - Poids Net : 102,4 kg

DT247 / DT245 / DT244 : Dimensions : 190/270 x 100 x h76 cm - Poids Net : 118,4 kg

DT247 / DT248 : Piétement en aluminium laqué gris anthracite

DT245 / DT246 : Piétement en aluminium laqué blanc

DT244 : Piétement en aluminium laqué gris cachemire

© Modèle déposé (Réf. INPI : 20222320)

## DINING TABLE

Top : Ceramic over glass 3 + 8 mm, colours : Matt marble **(MA)** or Silver **(SI)**

Two independant pull-out extensions

DT248 / DT246 : Dimensions : 150/230 x 100 x H76 cm - Net Weight : 102,4 kgs

DT247 / DT245 / DT244 : Dimensions : 190/270 x 100 x h76 cm - Net Weight : 118,4 kgs

DT247 / DT248 : Legs in grey anthracite lacquered aluminium

DT245 / DT246 : Legs in white lacquered aluminium

DT244 : Legs in grey cashemire lacquered aluminium

© Registered design (INPI : 20222320)

## ESSTISCH

3 mm Keramikplatte auf 8 mm starkem Glas, farben: Marmoroptik matt **(MA)** und silver **(SI)**

2 voneinander unabhängig einziehbare Verlängerungen

DT248 / DT246: Abmessung: 150/230 x 100 x H76 cm - Nettogewicht: 102,4 kg

DT247 / DT245 / DT244: Abmessung: 190/270 x 100 x H76 cm - Nettogewicht: 118,4 kg

DT247 / DT248: Gestell: Anthrazitgrau lackiertes Aluminium

DT245 / DT246: Gestell: weiß lackiertes Aluminium

DT244: Gestell: grau lackiertes Aluminium

© Registriertes Modell (INPI : 20222320)

# AKANTE®

## LÉON



# LÉON



			
CH020LE	: Vert citron	Lime	Limonengrün
CH020BL	: Bleu	Blue	Blau
CH020O	: Orange	Orange	Orange
CH020B	: Noir	Black	Schwarz
CH020RO1	: Rouge	Red	Rot
CH020W	: Blanc	White	Weiß
CH020T	: Taupe	Taupe	Taupe

 **CHAISE** CH020  
Chaise en Polypropylène (chaises empilables)

Largeur : 41 cm  
Profondeur : 50 cm  
Poids Net : 3,6 kg

Hauteur : 85 cm  
Hauteur assise : 46 cm

 **CHAIR** CH020  
Polypropylene chair (stacking chairs)

Width : 41 cm  
Depth : 50 cm  
Net Weight: 3,6 kgs

Height : 85 cm  
Seat height : 46 cm

 **STUHL** CH020  
Stuhl aus Polypropylen (stapelbar)

Breite: 41 cm  
Tiefe: 50 cm  
Nettogewicht: 3,6 kg

Höhe: 85 cm  
Sitzhöhe: 46 cm



# AKANTE®

MARCEAU®



# MARCEAU®



			
CH024LE	: Vert citron	Lime	Limonengrün
CH024BL	: Bleu	Blue	Blau
CH024O	: Orange	Orange	Orange
CH024B	: Noir	Black	Schwarz
CH024RO1	: Rouge	Red	Rot
CH024W	: Blanc	White	Weiß
CH024T	: Taupe	Taupe	Taupe

## CHAISE CH024

Chaise en polypropylène (chaises empilables)

Largeur : 47,5 cm      Hauteur : 80 cm  
Profondeur : 54 cm      Hauteur assise : 46 cm  
Poids Net : 4,2 kg

\* VENDU PAR LOT DE 2 CHAISES \*

© Modèle déposé (Réf. INPI : 20215513)

## CHAIR CH024

Polypropylene chair (stacking chairs)

Width : 47,5 cm      Height : 80 cm  
Depth : 54 cm      Seat height : 46 cm  
Net Weight : 4,2 kgs

\* SOLD BY 2 PIECES ONLY \*

© Registered design (INPI : 20215513)

## STUHL CH024

Stuhl aus Polypropylen (stapelbar)

Breite: 47,5 cm      Höhe: 80 cm  
Tiefe: 54 cm      Sitzhöhe: 46 cm  
Nettogewicht: 4,2 kg

\* NUR IM 2-er SET ERHÄLTlich \*

© Registriertes Modell (INPI : 20215513)

# AKANTE®

OCTAVE®



# OCTAVE<sup>®</sup>



CH028BL1 : Bleu

CH028VE : Vert pastel

CH028O : Orange

CH028B1 : Noir

CH028W : Blanc

CH028T : Taupe



Blue

Pastel green

Orange

Black

White

Taupe



Blau

Pastelgrün

Orange

Schwarz

Weiß

Taupe



## CHAISE

CH028

Chaise en Polypropylène (chaises empilables)

Largeur : 60 cm

Hauteur : 76 cm

Profondeur : 55 cm

Hauteur assise : 45 cm

Poids Net : 4,8 kg

© Modèle déposé (Réf. INPI : 20231433)



## CHAIR

CH028

Polypropylene chair (stacking chairs)

Width : 60 cm

Height : 76 cm

Depth : 55 cm

Seat height : 45 cm

Net Weight: 4,8 kgs

© Registered design (INPI : 20231433)



## STUHL

CH028

Stuhl aus Polypropylen (stapelbar)

Breite: 60 cm

Höhe: 76 cm

Tiefe: 55 cm

Sitzhöhe: 45 cm

Nettogewicht: 4,8 kg

© Registriertes Modell (INPI : 20231433)

# CONDITIONS GENERALES DE VENTE

## COMMANDE

Toute commande doit être adressée signée à AKANTE par email sur papier à en-tête de votre société. AKANTE vous confirmera votre commande sous 3 jours ouvrables email. Cette confirmation constituera le fait générateur de la formation du contrat de vente.

Toute commande adressée à AKANTE implique l'acceptation sans réserve des conditions générales de vente d'AKANTE.

En cas de présence de conditions générales d'achat, seule les conditions générales de vente d'AKANTE s'appliquent.

Les prix de facturation indiqués sont en Euros et s'entendent Hors Taxes. Nos offres de produits sont valables dans la limite des stocks disponibles ou des délais pour les produire. En cas d'indisponibilité d'un produit après confirmation de votre commande nous vous en informerons dans les meilleurs délais. Si toutefois une marchandise ne pouvait être livrée, étant devenue durablement indisponible, Akante se réserve le droit d'annuler le contrat de vente sans aucun dédommagement. Dans tout autre cas, la commande ne peut être annulée qu'après accord écrit des parties. Nous nous réservons le droit d'apporter à tout moment à nos modèles les modifications que nous jugerions utiles, sans obligation d'apporter celles-ci aux réalisations antérieures. Les couleurs et les finitions des matériels sont données à titre indicatif car il n'est pas possible d'en garantir l'invariabilité dans le temps. L'acheteur est pleinement conscient du fait que l'exposition à la lumière solaire des produits en bois et en verre peut altérer les couleurs ou modifier les couleurs et teintes. Nos notices, dépliants, plaquettes, catalogues...n'ont qu'un caractère indicatif et ne sauraient en aucun cas être considérés comme des offres fermes.

Nos finitions ne sont pas réputées fidèles et constantes comme des produits industriels : d'éventuelles différences d'un modèle à l'autre font partie des tolérances inhérentes aux procédés manuels mis en œuvre afin de créer un aspect intemporel.

Les prix figurant sur nos tarifs, catalogues ou autres supports ne sont donnés qu'à titre indicatif. Ils sont ceux en vigueur au jour de la livraison.

Toute variation de prix à la hausse comme à la baisse sera fixée selon l'avis du vendeur et l'acheteur déclare dès à présent en accepter les termes. Les contrats passés par nos agents ne sont définitifs qu'après avoir été confirmés par AKANTE.

## INTERNET

Sauf autorisation préalable écrite d'AKANTE, le client n'est nullement autorisé à vendre sur internet les produits achetés auprès d'AKANTE et n'est nullement autorisé à exploiter sur internet et sur tout autre support la marque AKANTE de quelque manière que ce soit.

## EXPEDITIONS

Nos commandes sont franco de port pour une commande supérieure à 600 euros. En deçà les frais de port sont de 20 euros.

Cas particuliers des commandes passées via L'Espace Pro du site internet [www.akante.com](http://www.akante.com): pour une commande comprenant uniquement des luminaires, le Franco est également de 600 Euros; en deçà, les frais de port sont de 20 Euros. Pour toute autre commande, et quel que soit le montant, les frais de port sont gratuits.

Cas spéciaux : Les modalités d'expédition s'appliquent exclusivement à des livraisons dans les magasins et les dépôts en France ou en Belgique. Ainsi, pour les livraisons "sur le trottoir" chez les particuliers, les frais de port s'élèvent à 50 Euros HT quels que soient le montant et le mode d'enregistrement de la commande (email, fax, téléphone, Espace Pro...). Pour les livraisons comprenant des prestations d'installation et de montage et nécessitant l'établissement d'un devis, veuillez nous consulter.

## RECLAMATIONS

Le client doit, avant de signer le bon de livraison, vérifier la conformité de la livraison : nombre et état des colis. En cas de doute sur l'état de la marchandise il est demandé de la déballer immédiatement et de faire des réserves écrites sur le bordereau de livraison. Aucune contestation liée au transport n'est recevable si le client n'a pas fait de réserves écrites sur le bordereau de livraison puis confirmé la réclamation par écrit, accompagnée de photos, en précisant clairement les motifs de la réclamation. Cette réclamation doit être adressée par email à cette adresse "info@akante.com" au plus tard dans les trois jours ouvrés qui suivent la livraison. Si la marchandise est trop endommagée, l'acheteur doit refuser le colis et contacter le service client par email à cette même adresse afin de convenir d'une nouvelle expédition de la commande.

Pour toute autre réclamation, nous demandons au client de déballer sa marchandise sous 10 jours calendaires après livraison et, en cas de problème, adresser dans ce délai sa réclamation accompagnée de photos par email à l'adresse "info@akante.com".

Toute réclamation formulée hors délais ou non accompagnée de photos ne pourra être acceptée. Tout retour physique de produits en notre entrepôt n'ayant pas fait l'objet d'une autorisation de retour de notre part sera refusé.

## REGLEMENTS

Pour tout client en France ou à l'Etranger : Règlement du montant de la commande à 30 JOURS NETS, date de facture.

En cas de non règlement de nos factures à leurs échéances, il nous sera dû, selon l'article Article L441 -6 du code du commerce, une indemnité dont le taux sera égale au taux d'intérêt appliqué par la Banque centrale européenne à son opération de refinancement la plus récente majoré de 10 points de pourcentage. Les pénalités de retard sont exigibles sans qu'un rappel soit nécessaire. Pour les frais de recouvrement que nous engagerons, vous nous devrez 10% du montant de la créance avec un minimum de 50€.

## CLAUSE DE RESERVE DE PROPRIETE

Le transfert de propriété de la marchandise n'intervient, nonobstant la livraison, qu'au paiement complet du prix de facturation. En conséquence, en cas de non- paiement des factures dues, AKANTE pourra se prévaloir du droit de revendication de la marchandise.

## CLAUSE DE CONFIDENTIALITE

Toute utilisation des designs et modèles, marques, textes, documents, illustrations et images autre que pour usage privé est constitutive de contrefaçon et sanctionnée au titre de la Propriété Intellectuelle ainsi qu'au titre du droit des marques, droit des brevets et droit à l'image, sauf autorisation préalable d'AKANTE. Toute reproduction totale ou partielle du catalogue d'AKANTE est strictement interdite.

## CLAUSE DE RESPONSABILITE

Au titre de la garantie des vices cachés, AKANTE ne sera tenue que du remplacement sans frais des marchandises défectueuses, sans que le client puisse prétendre à l'obtention de dommages et intérêts pour quelque cause que ce soit.

AKANTE ne pourrait être tenu pour responsable des dommages indirects et des préjudices financiers qui pourraient survenir du fait de l'achat, du transport, et de la livraison de ses produits.

La responsabilité d'AKANTE ne pourrait être engagée pour faits en cours de transport, de destruction, avaries, perte ou vol, même si AKANTE a choisi le transporteur.

## CLAUSE DE DROIT APPLICABLE

Ces conditions Générales de Vente sont soumises au droit français. En cas de contestation, le tribunal de commerce de Lille sera seul compétent, même en cas d'appel en garantie ou de pluralité de défendeurs.





AKANTE®

45/1 avenue de Flandre  
59290 Wasquehal - FRANCE  
Tel : +33 (0) 3 20 90 34 18 Fax : + 33 (0) 3 66 75 80  
Email : [info@akante.com](mailto:info@akante.com) - [www.akante.com](http://www.akante.com)